



Hebe-Senk-Bänder	6
Duschtürbänder mit Abdeckkappen	12
Duschtürbänder	19
Flächenbündige Duschtürbänder	30
Dusch-Schiebetürsystem	32
Türknöpfe	39
Winkelverbinder	41
Runde Dusch-Verstrebungen $\varnothing$ 19 mm	44
Runde Dusch-Verstrebungen $\varnothing$ 16 mm	46
Eckige Dusch-Verstrebungen	48
Dusch-Verstrebungen aus Glas	50
Handtuchhalter – Duschtürgriffe	51
Profile	53
Schwallschutz	55
Dichtungen	56



LH 401S L \*Mirissa

PC BL

Artikelnummer	Oberfläche	
LH 401S L.PC	Chrom glänzend	links
LH 401S L.BL	Schwarz matt	links

- Hebe-Senk-Band, mit Abdeckkappen
- Glas/Wand, 90°, **Lasche innen**
- für 6 - 8 mm Glas
- Hebung um ca. 5 mm



Max. Türgewicht: 36 kg/ 2 Bänder  
Max. Türbreite: 800 mm/ 2 Bänder

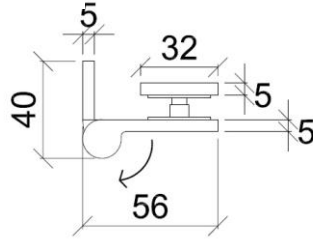
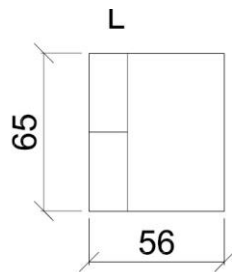

Glas Cut-Out

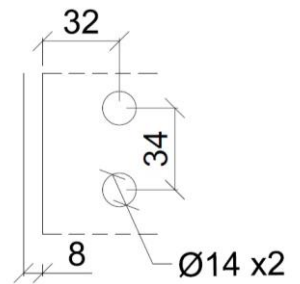

LH 401S R \*Mirissa

PC BL

Artikelnummer	Oberfläche	
LH 401S R.PC	Chrom glänzend	rechts
LH 401S R.BL	Schwarz matt	rechts

- Hebe-Senk-Band, mit Abdeckkappen
- Glas/Wand, 90°, **Lasche innen**
- für 6 - 8 mm Glas
- Hebung um ca. 5 mm



Max. Türgewicht: 36 kg/ 2 Bänder  
Max. Türbreite: 800 mm/ 2 Bänder

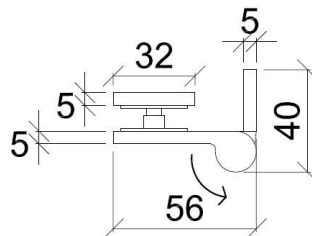
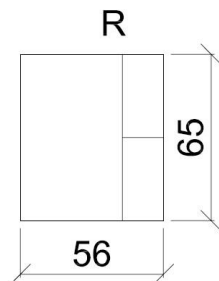

Glas Cut-Out

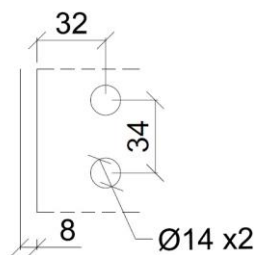

PLATE\_LH 400S \*Mirissa

PC

BL

Artikelnummer	Oberfläche
PLATE_LH 400S.PC	Chrom glänzend
PLATE_LH 400S.BL	Schwarz matt

- Montageplatte klein für Hebe-Senk-Band MIRISSA
- Glas/Wand, 90°
- Hebung um ca. 5 mm

1

Nur die Montageplatte, bitte extra bestellen  
Art. Nr. LH 401S L (links) oder Art. Nr. LH 401S R (rechts).

Für eine fachgerechte Montage der Bänder auf die Befestigung auf dem Untergrund achten, entsprechende bauseitige Maßnahmen.

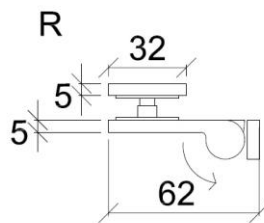
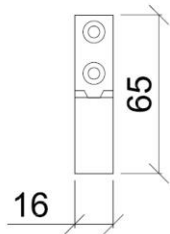
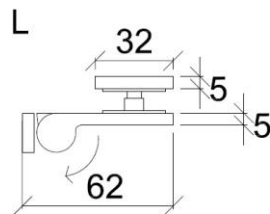
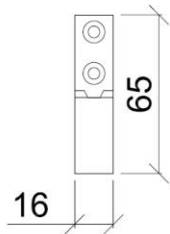

Glas Cut-Out

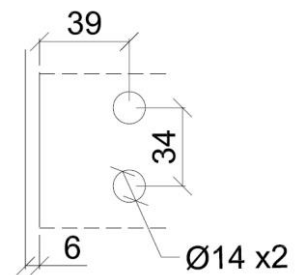

LH 402S L \*Mirissa

PC BL

Artikelnummer	Oberfläche	
LH 402S L.PC	Chrom glänzend	links
LH 402S L.BL	Schwarz matt	links

- Hebe-Senk-Band, mit Abdeckkappen
- Glas/Wand, 90°, **Lasche außen**
- für 6 - 8 mm Glas
- Hebung um ca. 5 mm



Max. Türgewicht: 36 kg/ 2 Bänder  
Max. Türbreite: 800 mm/ 2 Bänder

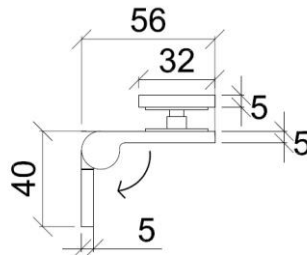
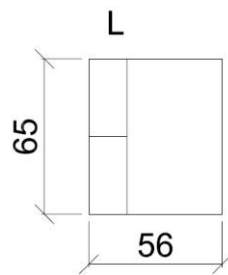

Glas Cut-Out

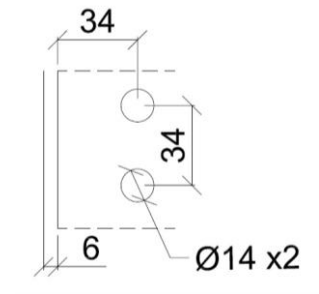

LH 402S R \*Mirissa

PC BL

Artikelnummer	Oberfläche	
LH 402S R.PC	Chrom glänzend	rechts
LH 402S R.BL	Schwarz matt	rechts

- Hebe-Senk-Band, mit Abdeckkappen
- Glas/Wand, 90°, **Lasche außen**
- für 6 - 8 mm Glas
- Hebung um ca. 5 mm



Max. Türgewicht: 36 kg/ 2 Bänder  
Max. Türbreite: 800 mm/ 2 Bänder

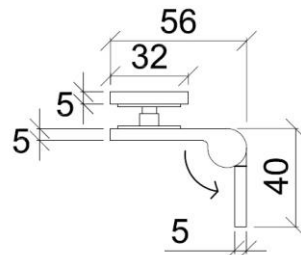
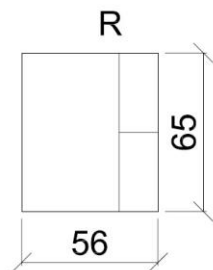

Glas Cut-Out

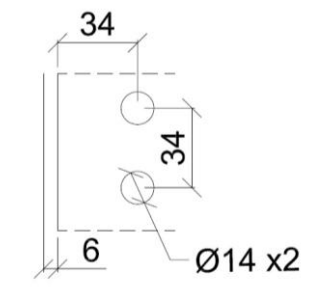

LH 403S L \*Mirissa

Artikelnummer	Oberfläche	
LH 403S L.PC	Chrom glänzend	links
LH 403S L.BL	Schwarz matt	links

PC

BL

- Hebe-Senk-Band, mit Abdeckkappen
- Glas/Glas, 180°
- für 6 - 8 mm Glas
- Hebung um ca. 5 mm

1



Max. Türgewicht: 36 kg/ 2 Bänder  
Max. Türbreite: 800 mm/ 2 Bänder

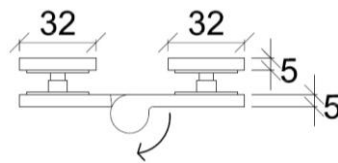
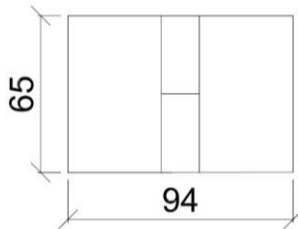

Glas Cut-Out

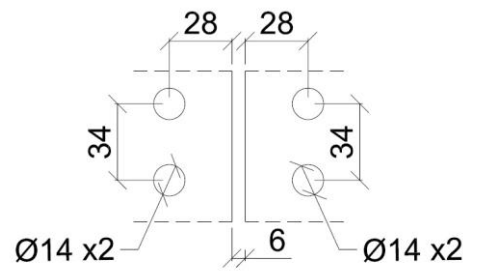

LH 403S R \*Mirissa

Artikelnummer	Oberfläche	
LH 403S R.PC	Chrom glänzend	rechts
LH 403S R.BL	Schwarz matt	rechts

PC

BL

- Hebe-Senk-Band, mit Abdeckkappen
- Glas/Glas, 180°
- für 6 - 8 mm Glas
- Hebung um ca. 5 mm



Max. Türgewicht: 36 kg/ 2 Bänder  
Max. Türbreite: 800 mm/ 2 Bänder

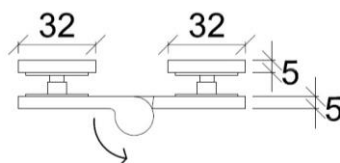
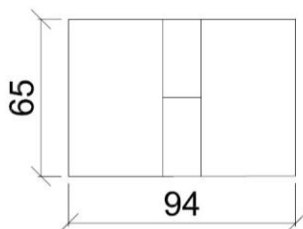

Glas Cut-Out

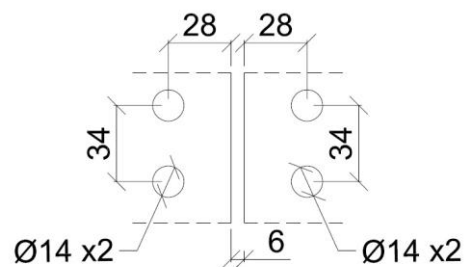

**GC 407S \*Mirissa**

PC

BL

Artikelnummer	Oberfläche
GC 407S.PC	Chrom glänzend
GC 407S.BL	Schwarz matt

- Winkelverbinder, mit Abdeckkappen
- Glas/Wand, 90°
- für 6 - 8 mm Glas

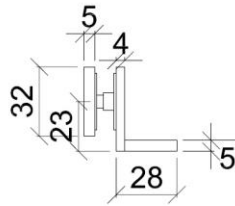
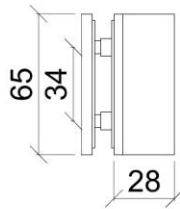

Glas Cut-Out

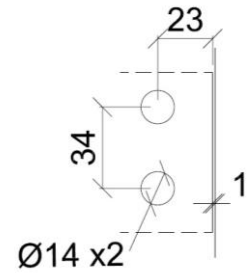

**GC 404S \*Mirissa**

PC

BL

Artikelnummer	Oberfläche
GC 404S.PC	Chrom glänzend
GC 404S.BL	Schwarz matt

- Winkelverbinder, mit Abdeckkappen
- Glas/Glas, 90°
- für 6 - 8 mm Glas

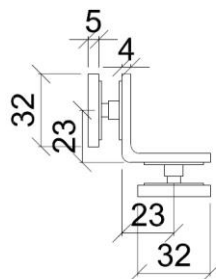
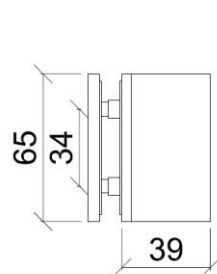

Glas Cut-Out

A = Glasstärke 6 mm bzw. 8 mm

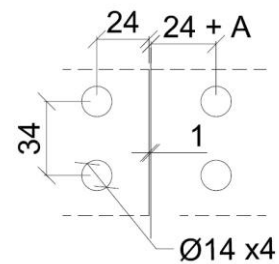

SR-60

PC BN

Artikelnummer	Oberfläche	
SR-60 L.PC	Chrom glänzend	links
SR-60 L.BN	Edelstahl matt	links
SR-60 R.PC	Chrom glänzend	rechts
SR-60 R.BN	Edelstahl matt	rechts

- Hebe-Senk-Band
- Glas/Wand, 90°, einseitig
- für 8 – 10 mm Glas

1



Max. Türgewicht: 45 kg/ 2 Bänder  
 Max. Türbreite: 800 mm/ 2 Bänder  
 Max. Türhöhe: 2100 mm/ 2 Bänder

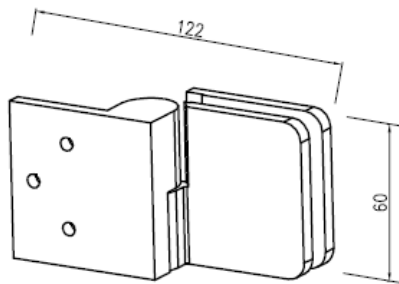

Glas Cut-Out

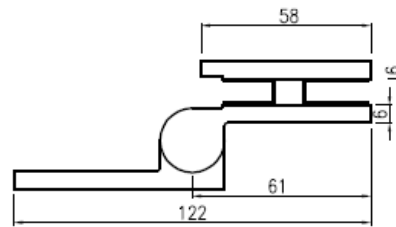
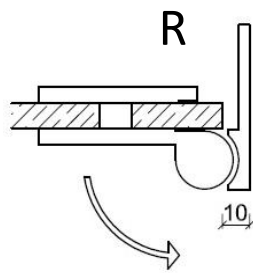
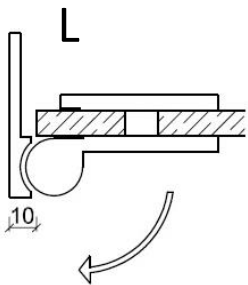
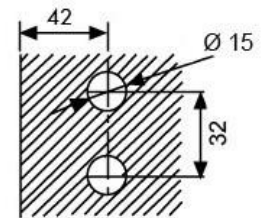

### AHC 700S

PC

Artikelnummer	Oberfläche
AHC 700S.PC	Chrom glänzend

- Pendeltürband mit einstellbarer Nulllage
- mit Abdeckkappen
- Glas/Wand, 90°, einseitig
- für 8 – 10 mm Glas

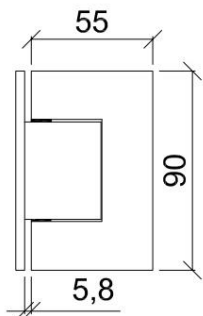

Max. Türgewicht: 40 kg/ 2 Bänder  
Max. Türbreite: 1000 mm/ 2 Bänder

Max. Türgewicht: 55 kg/ 3 Bänder  
Max. Türbreite: 1000 mm/ 3 Bänder

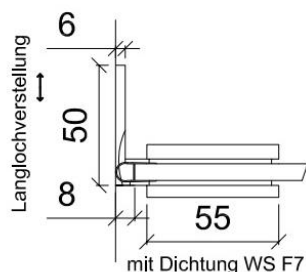
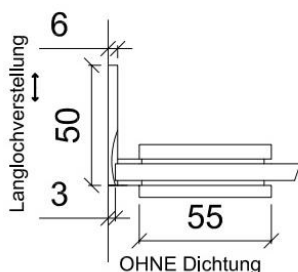

Glas Cut-Out

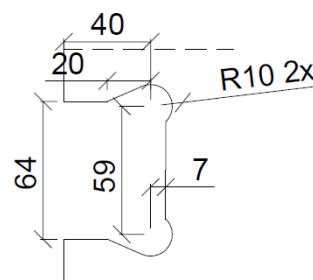

### AHC 701S

PC

BN

Artikelnummer	Oberfläche
AHC 701S.PC	Chrom glänzend
AHC 701S.BN	Edelstahl matt

- Pendeltürband mit einstellbarer Nulllage
- mit Abdeckkappen
- Glas/Wand, 90°, beidseitig
- für 8 – 10 mm Glas

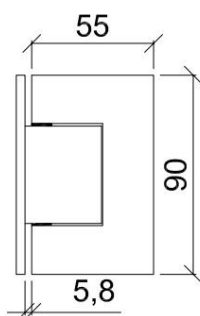

Max. Türgewicht: 40 kg/ 2 Bänder  
Max. Türbreite: 1000 mm/ 2 Bänder

Max. Türgewicht: 55 kg/ 3 Bänder  
Max. Türbreite: 1000 mm/ 3 Bänder

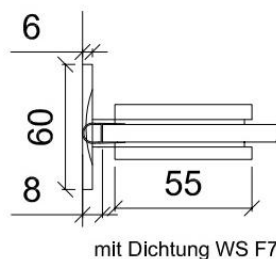
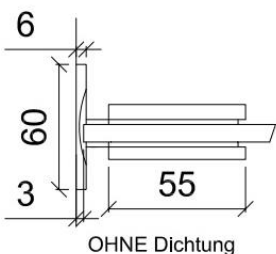

Glas Cut-Out

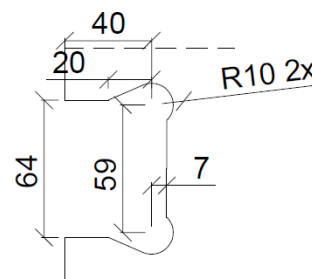



AHC 703S

PC BN

Artikelnummer	Oberfläche
AHC 703S.PC	Chrom glänzend
AHC 703S.BN	Edelstahl matt

- Pendeltürband mit einstellbarer Nulllage
- mit Abdeckkappen
- Glas/Glas, 180°
- für 8 – 10 mm Glas

1

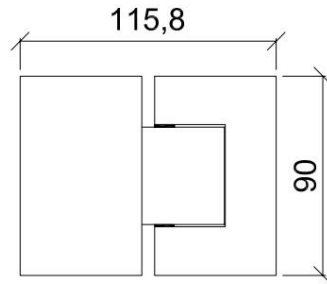

Max. Türgewicht: 40 kg/ 2 Bänder  
Max. Türbreite: 1000 mm/ 2 Bänder

Max. Türgewicht: 55 kg/ 3 Bänder  
Max. Türbreite: 1000 mm/ 3 Bänder

Glas Cut-Out

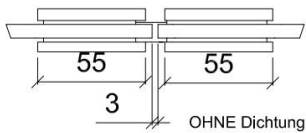
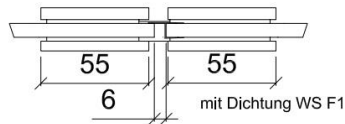
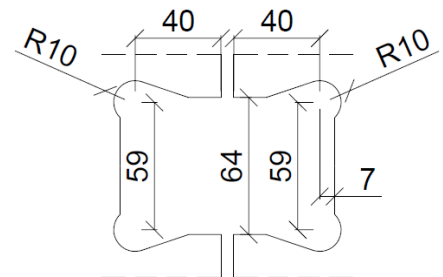

**GCC 907S**

Artikelnummer	Oberfläche
GCC 907S.PC	Chrom glänzend
GCC 907S.BN	Edelstahl matt

PC BN

- Winkelverbinder
- mit Abdeckkappen
- Glas/Wand, 90°
- für 8 – 10 mm Glas

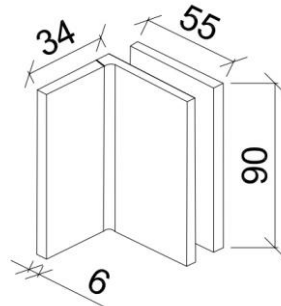

Glas Cut-Out

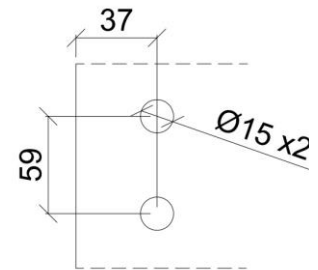

**GCC 904S**

Artikelnummer	Oberfläche
GCC 904S.PC	Chrom glänzend
GCC 904S.BN	Edelstahl matt

PC BN

- Winkelverbinder
- mit Abdeckkappen
- Glas/Glas, 90°
- für 8 – 10 mm Glas

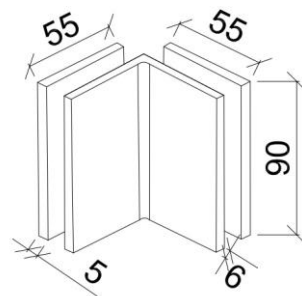

Glas Cut-Out

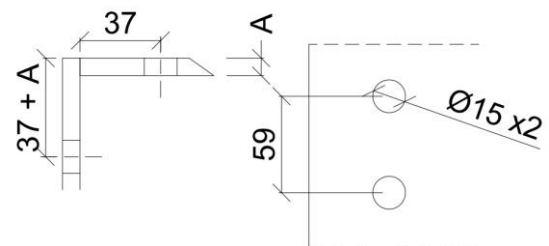

**AHC 700C**

Artikelnummer	Oberfläche
AHC 700C.PC	Chrom glänzend
AHC 700C.BN	Edelstahl matt

PC BN

- Pendeltürband mit einstellbarer Nulllage
- mit Abdeckkappen
- Glas/Wand, 90°, einseitig
- für 8 – 10 mm Glas

1

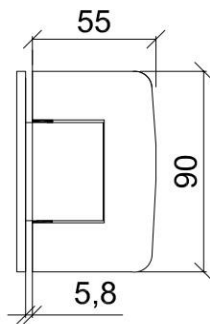

Max. Türgewicht: 40 kg/ 2 Bänder  
Max. Türbreite: 1000 mm/ 2 Bänder

Max. Türgewicht: 55 kg/ 3 Bänder  
Max. Türbreite: 1000 mm/ 3 Bänder

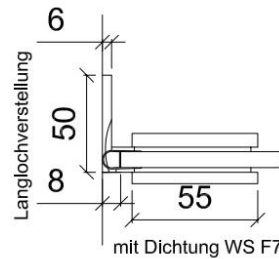
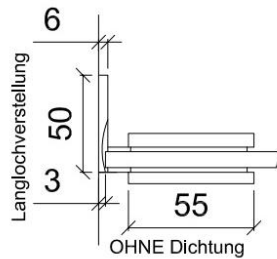

Glas Cut-Out

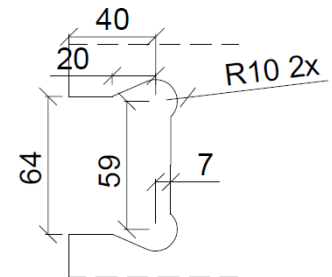

**AHC 703C**

Artikelnummer	Oberfläche
AHC 703C.PC	Chrom glänzend
AHC 703C.BN	Edelstahl matt

PC BN

- Pendeltürband mit einstellbarer Nulllage
- mit Abdeckkappen
- Glas/Glas, 180°
- für 8 – 10 mm Glas

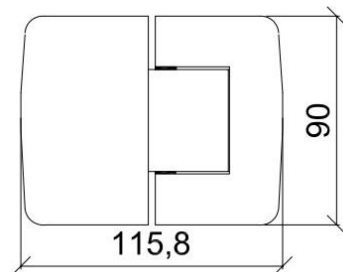

Max. Türgewicht: 40 kg/ 2 Bänder  
Max. Türbreite: 1000 mm/ 2 Bänder

Max. Türgewicht: 55 kg/ 3 Bänder  
Max. Türbreite: 1000 mm/ 3 Bänder

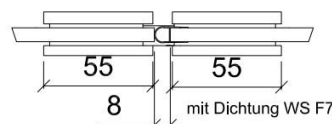
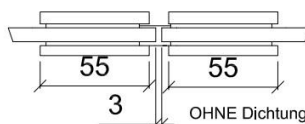
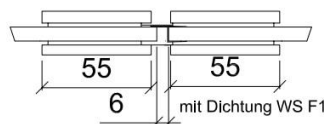

Glas Cut-Out

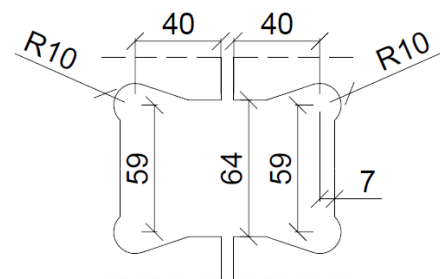

**GCC 907C**

PC BN

Artikelnummer	Oberfläche
GCC 907C.PC	Chrom glänzend
GCC 907C.BN	Edelstahl matt

- Winkelverbinder
- mit Abdeckkappen
- Glas/Wand, 90°
- für 8 – 10 mm Glas

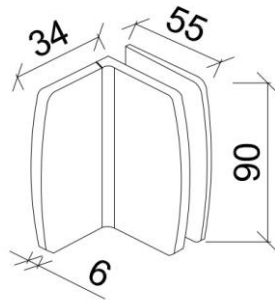

Glas Cut-Out

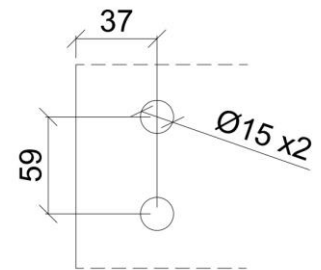

**GCC 904C**

PC BN

Artikelnummer	Oberfläche
GCC 904C.PC	Chrom glänzend
GCC 904C.BN	Edelstahl matt

- Winkelverbinder
- mit Abdeckkappen
- Glas/Glas, 90°
- für 8 – 10 mm Glas

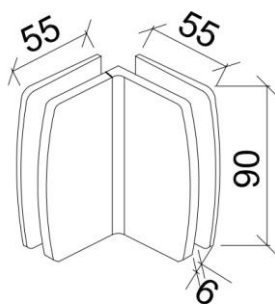

Glas Cut-Out

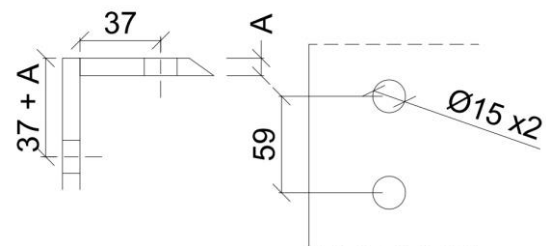

OHC 700S

Artikelnummer	Oberfläche
OHC 700S.PC	Chrom glänzend
OHC 700S.BN	Edelstahl matt
OHC 700S.BL	Schwarz matt

PC BN BL

- Pendeltürband mit einstellbarer Nulllage
- geringes Spaltmaß
- mit Abdeckkappen
- Glas/Wand, 90°, einseitig
- für 8 – 10 mm Glas

1



Max. Türgewicht: 40 kg/ 2 Bänder  
Max. Türbreite: 1000 mm/ 2 Bänder

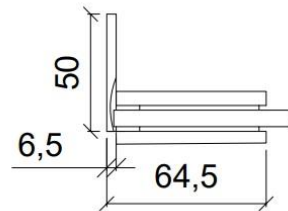
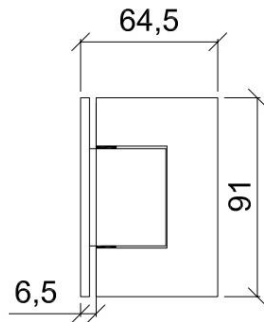

Glas Cut-Out

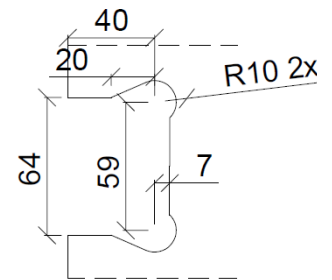

OHC 703S

Artikelnummer	Oberfläche
OHC 703S.PC	Chrom glänzend
OHC 703S.BN	Edelstahl matt
OHC 703S.BL	Schwarz matt

PC BN BL

- Pendeltürband mit einstellbarer Nulllage
- geringes Spaltmaß
- mit Abdeckkappen
- Glas/Glas, 180°
- für 8 – 10 mm Glas



Max. Türgewicht: 40 kg/ 2 Bänder  
Max. Türbreite: 1000 mm/ 2 Bänder

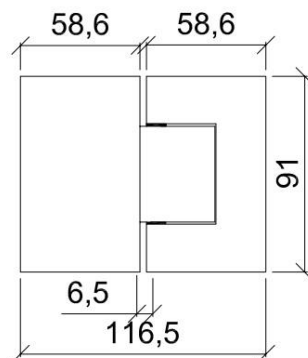

Glas Cut-Out

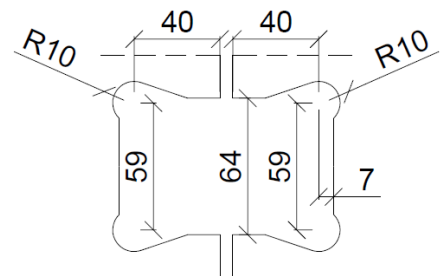

**OGCC 907S**

PC **BL**

Artikelnummer	Oberfläche
OGCC 907S.PC	Chrom glänzend
OGCC 907S.BL	Schwarz matt

- Winkelverbinder
- mit Abdeckkappen
- Glas/Wand, 90°
- für 8 – 10 mm Glas

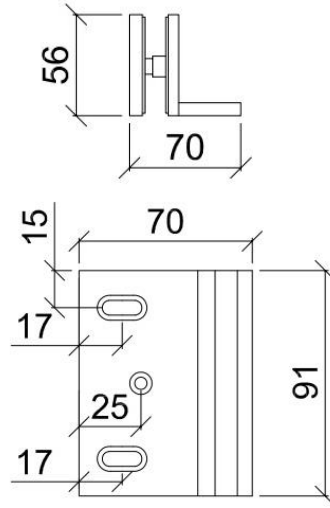

Glas Cut-Out

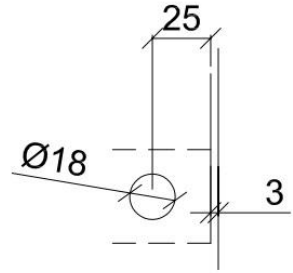

Der Klassiker

1

AH 700S

PC BN

Artikelnummer	Oberfläche
AH 700S.PC	Chrom glänzend
AH 700S.BN	Edelstahl matt

- Pendeltürband mit einstellbarer Nulllage
- Glas/Wand, 90°, einseitig
- für 8 – 10 mm Glas



Max. Türgewicht: 40 kg/ 2 Bänder  
Max. Türbreite: 1000 mm/ 2 Bänder

Max. Türgewicht: 55 kg/ 3 Bänder  
Max. Türbreite: 1000 mm/ 3 Bänder

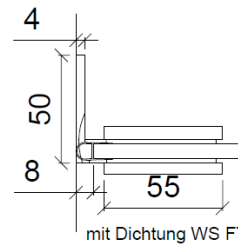
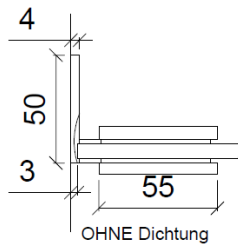
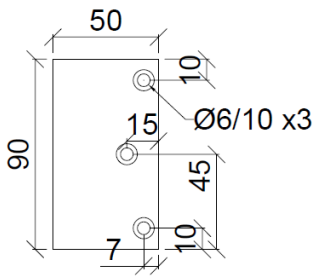
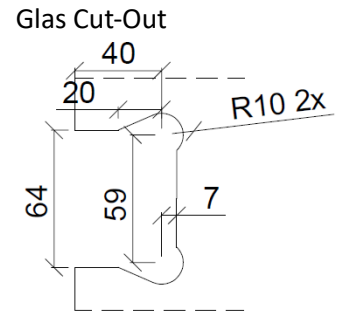
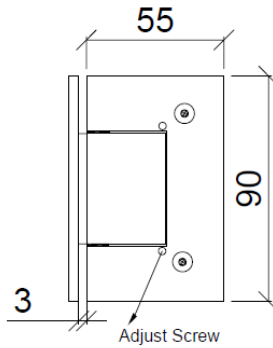

AH 701S

PC BN

Der Klassiker

Artikelnummer	Oberfläche
AH 701S.PC	Chrom glänzend
AH 701S.BN	Edelstahl matt

- Pendeltürband mit einstellbarer Nulllage
- Glas/Wand, 90°, beidseitig
- für 8 – 10 mm Glas



Max. Türgewicht: 40 kg/ 2 Bänder  
Max. Türbreite: 1000 mm/ 2 Bänder

Max. Türgewicht: 55 kg/ 3 Bänder  
Max. Türbreite: 1000 mm/ 3 Bänder

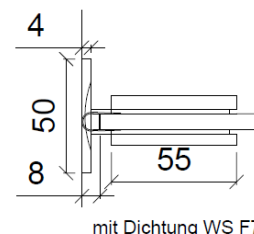
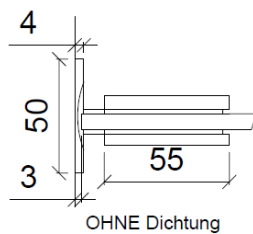
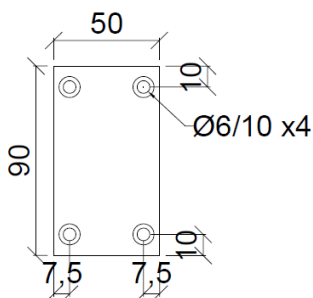
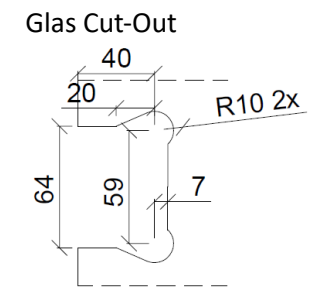
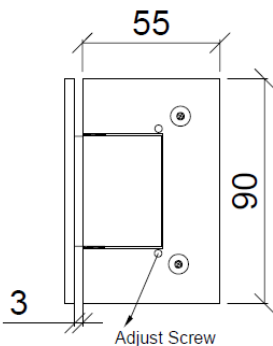

### AH 703S

Artikelnummer	Oberfläche
AH 703S.PC	Chrom glänzend
AH 703S.BN	Edelstahl matt

PC BN

Der Klassiker

- Pendeltürband mit einstellbarer Nulllage
- Glas/Glas, 180°
- für 8 – 10 mm Glas



Max. Türgewicht: 40 kg/ 2 Bänder  
Max. Türbreite: 1000 mm/ 2 Bänder

Max. Türgewicht: 55 kg/ 3 Bänder  
Max. Türbreite: 1000 mm/ 3 Bänder

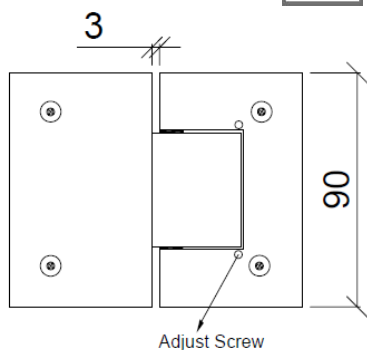

Glas Cut-Out

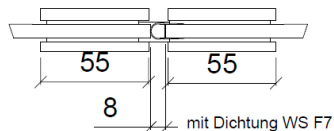
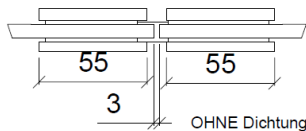
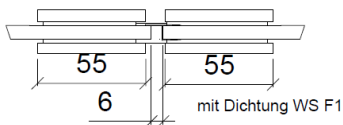
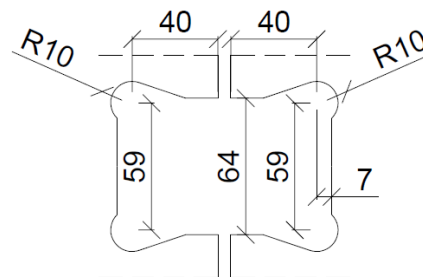

### AH 704S

Artikelnummer	Oberfläche
AH 704S.PC	Chrom glänzend
AH 704S.BN	Edelstahl matt

PC BN

Der Klassiker

- Pendeltürband mit einstellbarer Nulllage
- Glas/Glas, 90°
- für 8 – 10 mm Glas



Max. Türgewicht: 40 kg/ 2 Bänder  
Max. Türbreite: 1000 mm/ 2 Bänder

Max. Türgewicht: 55 kg/ 3 Bänder  
Max. Türbreite: 1000 mm/ 3 Bänder

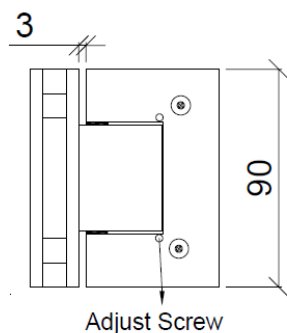

Glas Cut-Out

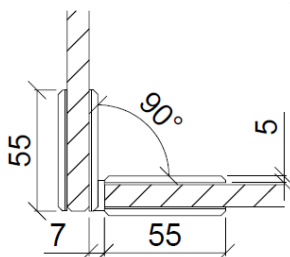
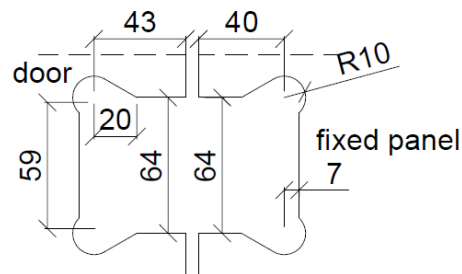



Der Klassiker

1

AH 705S

PC BN

Artikelnummer	Oberfläche
AH 705S.PC	Chrom glänzend
AH 705S.BN	Edelstahl matt

- Pendeltürband mit einstellbarer Nulllage
- Glas/Glas, 135°
- für 8 – 10 mm Glas



Max. Türgewicht: 40 kg/ 2 Bänder  
Max. Türbreite: 1000 mm/ 2 Bänder

Max. Türgewicht: 55 kg/ 3 Bänder  
Max. Türbreite: 1000 mm/ 3 Bänder

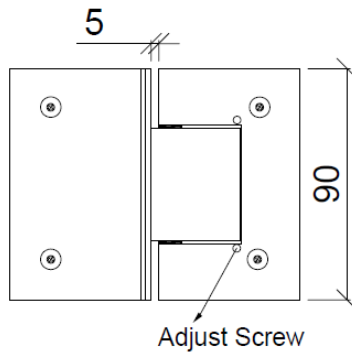
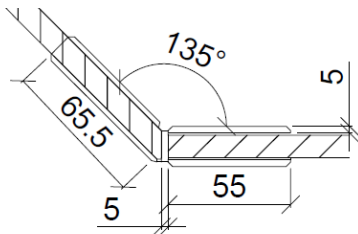

Glas Cut-Out (mit Gehrungsschliff)

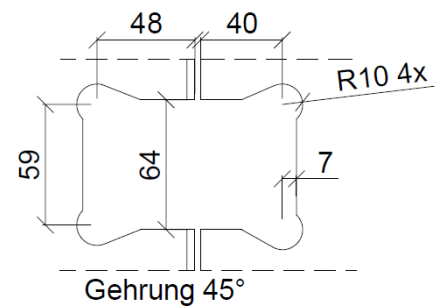

Glas Cut-Out (ohne Gehrungsschliff)

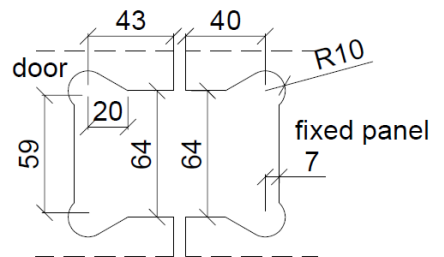

**GC 907S**

Artikelnummer	Oberfläche
GC 907S.PC	Chrom glänzend
GC 907S.BN	Edelstahl matt

PC BN

Der Klassiker

- Winkelverbinder
- Glas/Wand, 90°
- für 8 – 10 mm Glas

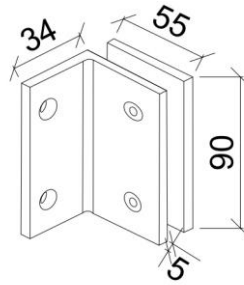

Glas Cut-Out

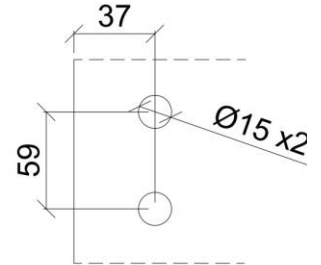

**GC 904S**

Artikelnummer	Oberfläche
GC 904S.PC	Chrom glänzend
GC 904S.BN	Edelstahl matt

PC BN

Der Klassiker

- Winkelverbinder
- Glas/Glas, 90°
- für 8 – 10 mm Glas

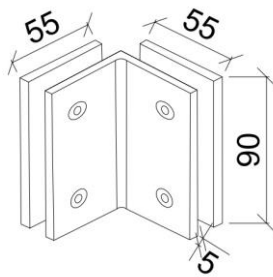

Glas Cut-Out

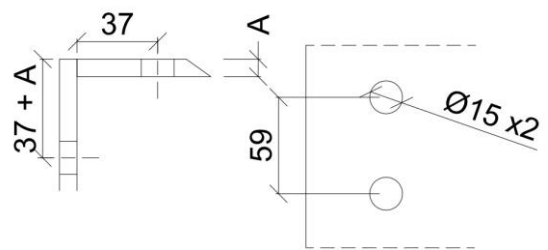

**AH 700C**

PC BN

Artikelnummer	Oberfläche
AH 700C.PC	Chrom glänzend
AH 700C.BN	Edelstahl matt

- Pendeltürband mit einstellbarer Nulllage
- Glas/Wand, 90°, einseitig
- für 8 – 10 mm Glas

1



Max. Türgewicht: 40 kg/ 2 Bänder  
Max. Türbreite: 1000 mm/ 2 Bänder

Max. Türgewicht: 55 kg/ 3 Bänder  
Max. Türbreite: 1000 mm/ 3 Bänder

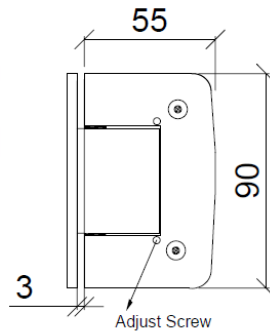

Glas Cut-Out

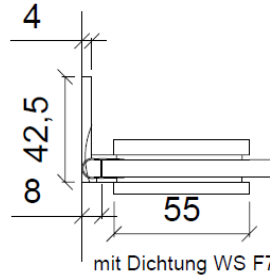
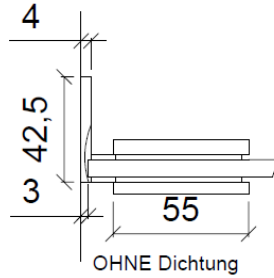
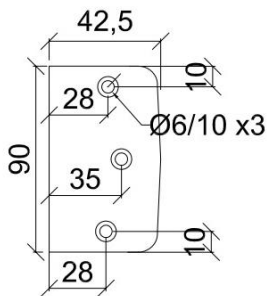
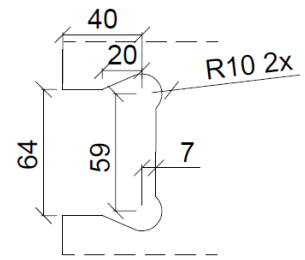

**AH 701C**

PC BN

Artikelnummer	Oberfläche
AH 701C.PC	Chrom glänzend
AH 701C.BN	Edelstahl matt

- Pendeltürband mit einstellbarer Nulllage
- Glas/Wand, 90°, beidseitig
- für 8 – 10 mm Glas



Max. Türgewicht: 40 kg/ 2 Bänder  
Max. Türbreite: 1000 mm/ 2 Bänder

Max. Türgewicht: 55 kg/ 3 Bänder  
Max. Türbreite: 1000 mm/ 3 Bänder

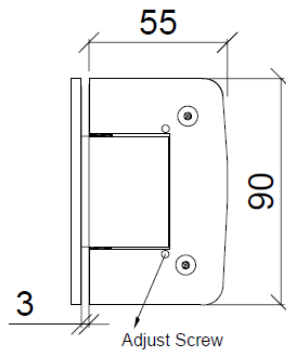

Glas Cut-Out

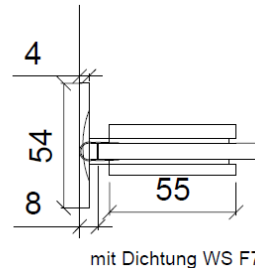
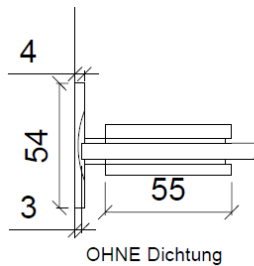
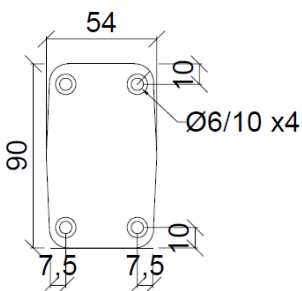
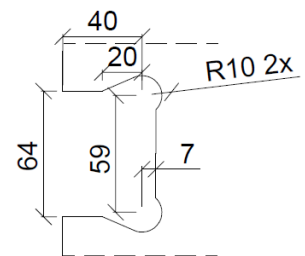

**AH 703C**

PC BN

Artikelnummer	Oberfläche
AH 703C.PC	Chrom glänzend
AH 703C.BN	Edelstahl matt

- Pendeltürband mit einstellbarer Nulllage
- Glas/Glas, 180°
- für 8 – 10 mm Glas



Max. Türgewicht: 40 kg/ 2 Bänder  
Max. Türbreite: 1000 mm/ 2 Bänder

Max. Türgewicht: 55 kg/ 3 Bänder  
Max. Türbreite: 1000 mm/ 3 Bänder

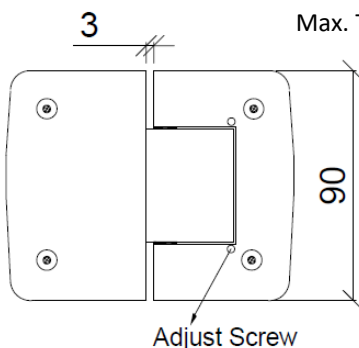

Glas Cut-Out

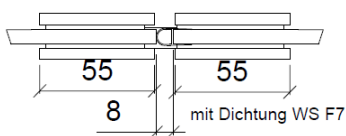
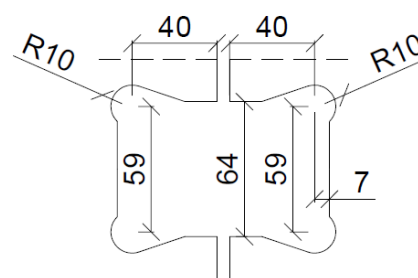

**AH 704C**

PC BN

Artikelnummer	Oberfläche
AH 704C.PC	Chrom glänzend
AH 704C.BN	Edelstahl matt

- Pendeltürband mit einstellbarer Nulllage
- Glas/Glas, 90°
- für 8 – 10 mm Glas



Max. Türgewicht: 40 kg/ 2 Bänder  
Max. Türbreite: 1000 mm/ 2 Bänder

Max. Türgewicht: 55 kg/ 3 Bänder  
Max. Türbreite: 1000 mm/ 3 Bänder

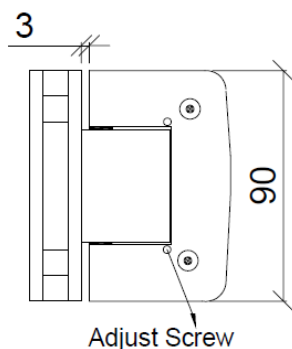

Glas Cut-Out

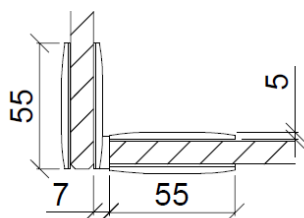
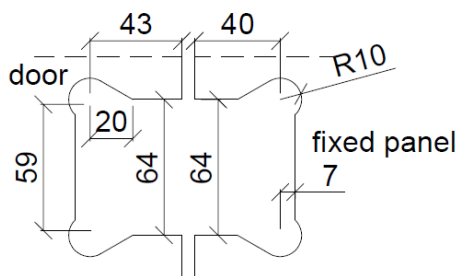

AH 705C

PC BN

Artikelnummer	Oberfläche
AH 705C.PC	Chrom glänzend
AH 705C.BN	Edelstahl matt

- Pendeltürband mit einstellbarer Nulllage
- Glas/Glas, 135°
- für 8 – 10 mm Glas

1

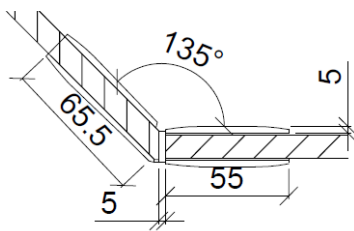

Max. Türgewicht: 40 kg/ 2 Bänder  
Max. Türbreite: 1000 mm/ 2 Bänder

Max. Türgewicht: 55 kg/ 3 Bänder  
Max. Türbreite: 1000 mm/ 3 Bänder

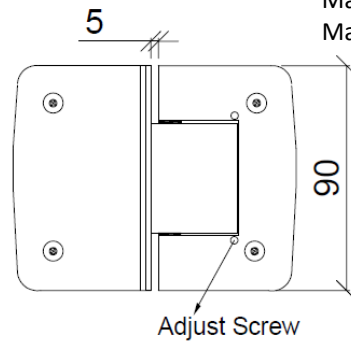

Glas Cut-Out (mit Gehrungsschliff)

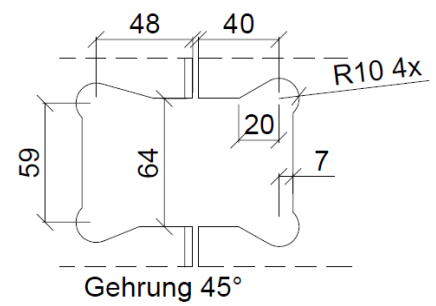

Glas Cut-Out (ohne Gehrungsschliff)

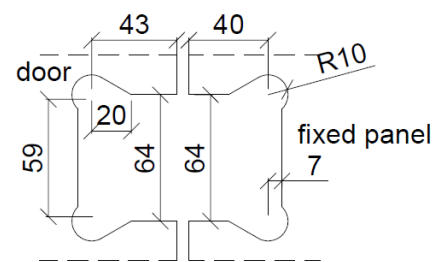

**GC 907C**

PC BN

Artikelnummer	Oberfläche
GC 907C.PC	Chrom glänzend
GC 907C.BN	Edelstahl matt

- Winkelverbinder
- Glas/Wand, 90°
- für 8 – 10 mm Glas

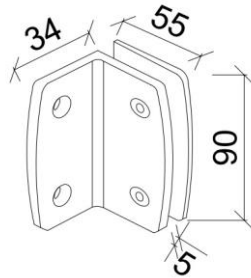

Glas Cut-Out

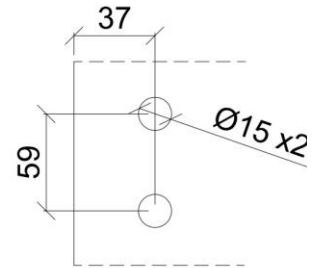

**GC 904C**

PC BN

Artikelnummer	Oberfläche
GC 904C.PC	Chrom glänzend
GC 904C.BN	Edelstahl matt

- Winkelverbinder
- Glas/Glas, 90°
- für 8 – 10 mm Glas

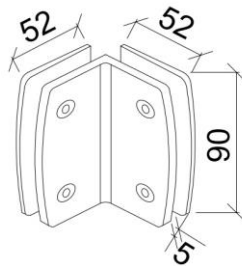

Glas Cut-Out

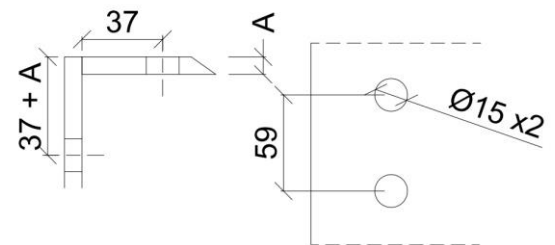

## AH 800C

Artikelnummer	Oberfläche
AH 800C.PC	Chrom glänzend
AH 800C.BN	Edelstahl matt

PC BN

- Pendeltürband mit einstellbarer Nulllage
- Glas/Wand, 90°, einseitig
- für 6 – 8 mm Glas



Max. Türgewicht: 25 kg/ 2 Bänder  
Max. Türbreite: 762 mm/ 2 Bänder

Max. Türgewicht: 40 kg/ 3 Bänder  
Max. Türbreite: 915 mm/ 3 Bänder

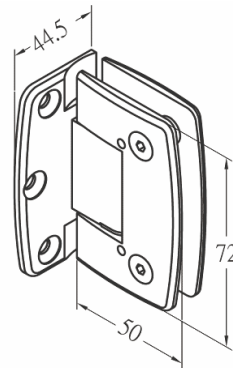

Glas Cut-Out

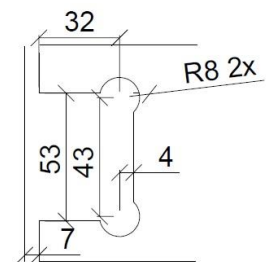

## AH 801C

Artikelnummer	Oberfläche
AH 801C.PC	Chrom glänzend
AH 801C.BN	Edelstahl matt

PC BN

- Pendeltürband mit einstellbarer Nulllage
- Glas/Wand, 90°, beidseitig
- für 6 – 8 mm Glas



Max. Türgewicht: 25 kg/ 2 Bänder  
Max. Türbreite: 762 mm/ 2 Bänder

Max. Türgewicht: 40 kg/ 3 Bänder  
Max. Türbreite: 915 mm/ 3 Bänder

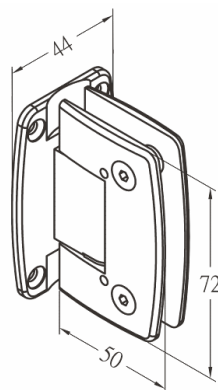

Glas Cut-Out

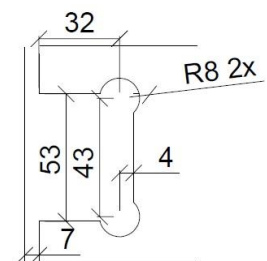

AH 803C

PC BN

Artikelnummer	Oberfläche
AH 803C.PC	Chrom glänzend
AH 803C.BN	Edelstahl matt

- Pendeltürband mit einstellbarer Nulllage
- Glas/Glas, 180°
- für 6 – 8 mm Glas



Max. Türgewicht: 25 kg/ 2 Bänder  
 Max. Türbreite: 762 mm/ 2 Bänder

Max. Türgewicht: 40 kg/ 3 Bänder  
 Max. Türbreite: 915 mm/ 3 Bänder

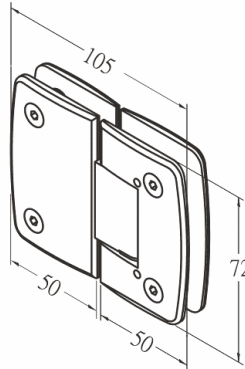

Glas Cut-Out

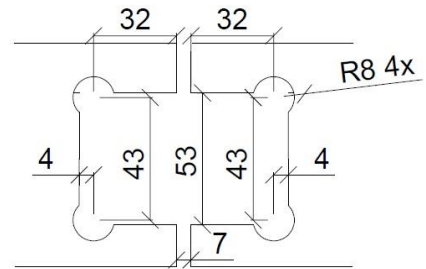



### OH 700S

PC BN

Artikelnummer	Oberfläche
OH 700S.PC	Chrom glänzend
OH 700S.BN	Edelstahl matt

- Pendeltürband mit einstellbarer Nulllage
- Glas/Wand, 90°, einseitig
- für 8 – 10 mm Glas

1



Max. Türgewicht: 40 kg/ 2 Bänder  
Max. Türbreite: 800 mm/ 2 Bänder

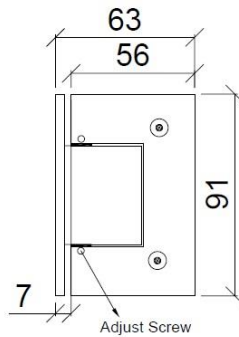

Glas Cut-Out

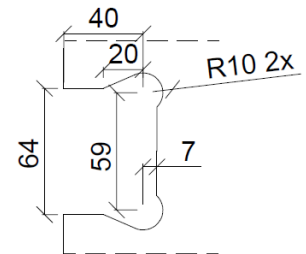

### OH 703S

PC BN

Artikelnummer	Oberfläche
OH 703S.PC	Chrom glänzend
OH 703S.BN	Edelstahl matt

- Pendeltürband mit einstellbarer Nulllage
- Glas/Glas, 180°
- für 8 – 10 mm Glas



Max. Türgewicht: 40 kg/ 2 Bänder  
Max. Türbreite: 800 mm/ 2 Bänder

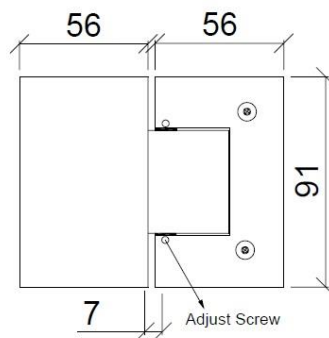

Glas Cut-Out

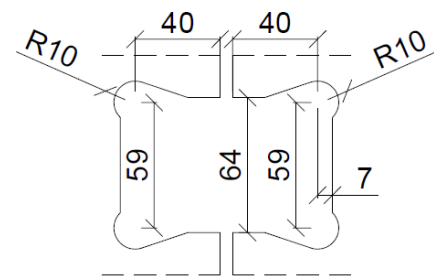

**FH 201C**

Artikelnummer	Oberfläche
FH 201C.PC	Chrom glänzend
FH 201C.BN	Edelstahl matt

PC BN

- Flächenbündiges, freidrehendes Band
- Glas/Wand, 90°, einseitig
- für 8 – 10 mm Glas

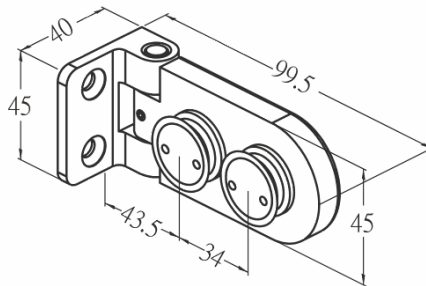

Max. Türgewicht: 36 kg/ 2 Bänder  
Max. Türbreite: 711 mm/ 2 Bänder

Max. Türgewicht: 50 kg/ 3 Bänder  
Max. Türbreite: 813 mm/ 3 Bänder

Glas Cut-Out

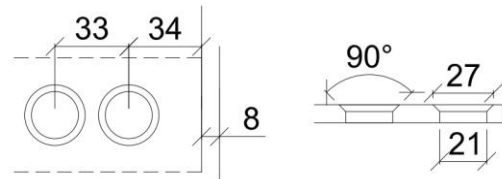

**FH 202C**

Artikelnummer	Oberfläche
FH 202C.PC	Chrom glänzend
FH 202C.BN	Edelstahl matt

PC BN

- Flächenbündiges, freidrehendes Band
- Glas/Wand, 90°, einseitig
- für 8 – 10 mm Glas

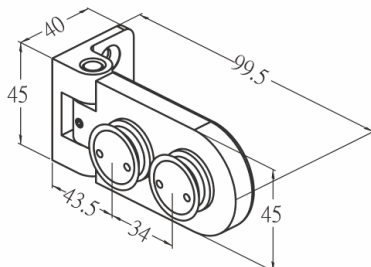

Max. Türgewicht: 36 kg/ 2 Bänder  
Max. Türbreite: 711 mm/ 2 Bänder

Max. Türgewicht: 50 kg/ 3 Bänder  
Max. Türbreite: 813 mm/ 3 Bänder

Glas Cut-Out

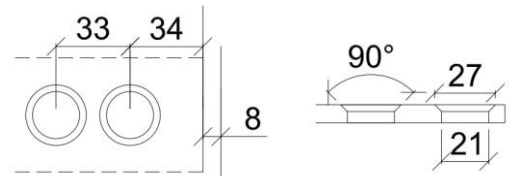

FH 203C

Artikelnummer	Oberfläche
FH 203C.PC	Chrom glänzend
FH 203C.BN	Edelstahl matt

PC BN

- Flächenbündiges, freidrehendes Band
- Glas/Glas
- für 8 – 10 mm Glas

1

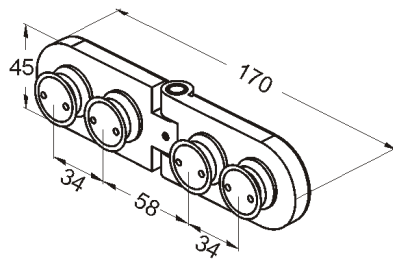

Max. Türgewicht: 36 kg/ 2 Bänder  
Max. Türbreite: 711 mm/ 2 Bänder

Max. Türgewicht: 50 kg/ 3 Bänder  
Max. Türbreite: 813 mm/ 3 Bänder

Glas Cut-Out

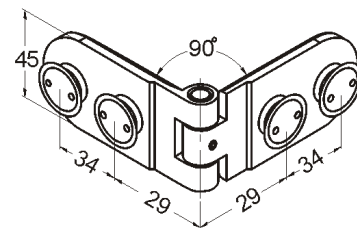
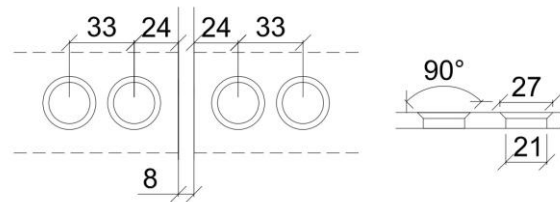

Glass to glass for 90°

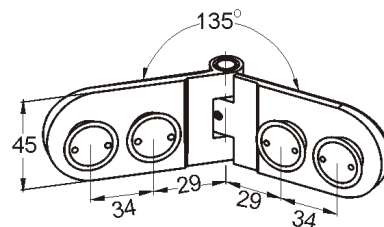

Glass to glass for 135°



**SET N**  
Nischendusche

PC BL

S-180 – Set N  
Laufschiene L = 1800 mm

S-200 – Set N  
Laufschiene L = 2000 mm

→ Seite 33

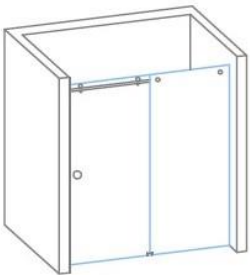

**SET C2Fix**  
Eckdusche mit 2 Fixteilen

PC BL

S-180 – Set C2Fix  
Laufschiene L = 1800 mm

S-200 – Set C2Fix  
Laufschiene L = 2000 mm

→ Seite 34



**SET U**  
U-Förmige Dusche

PC BL

S-180 – Set U  
Laufschiene L = 1800 mm

S-200 – Set U  
Laufschiene L = 2000 mm

→ Seite 35

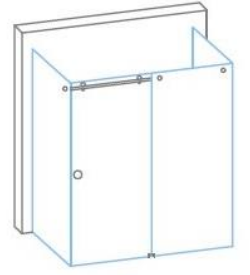

**SET C**  
Eckdusche

PC BL

S-180\_Typ 1 – Set C  
1x Laufschiene L = 1800 mm

S-180\_Typ 2 – Set C  
2x Laufschiene L = 1800 mm

S-200 – Set C  
1x Laufschiene L = 2000 mm

→ Seite 36

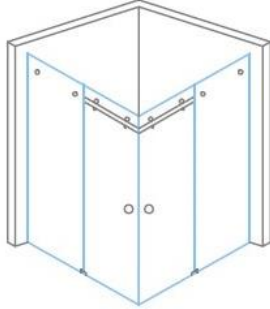

**SET N2Fix**  
Nischendusche mit 2 Fixteilen

PC

S-300 – Set N2Fix  
Laufschiene L = 3000 mm

→ Seite 37

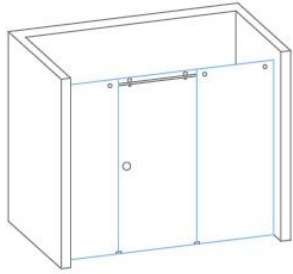

**SET N2Do2Fix**  
Nischendusche mit 2 Türen und 2 Fixteilen

PC

S-300 – Set N2Do2Fix  
Laufschiene L = 3000 mm

→ Seite 38

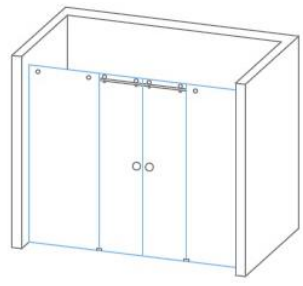
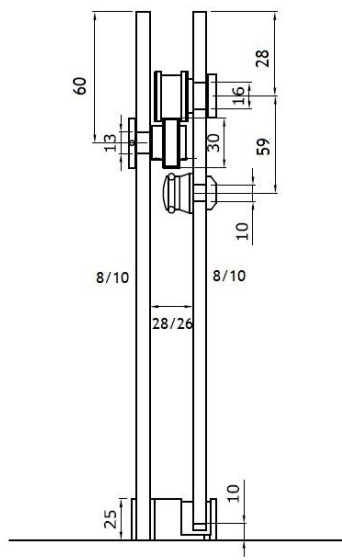
SET N

PC

BL

Artikelnummer	Oberfläche	Laufschiene
S-180 – Set N PC	Chrom glänzend	1 Stk. L = 1800 mm
S-200 – Set N PC	Chrom glänzend	1 Stk. L = 2000 mm
S-200 – Set N BL	Schwarz matt	1 Stk. L = 2000 mm

- Nischendusche
- inkl. 1 Paar Griffmuschel SD K07
- für 8 mm bzw. 10 mm Glas

1

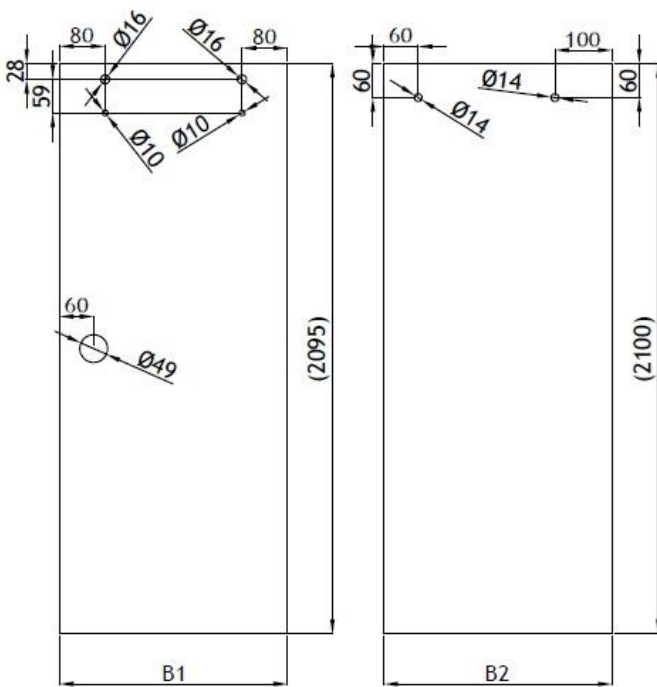
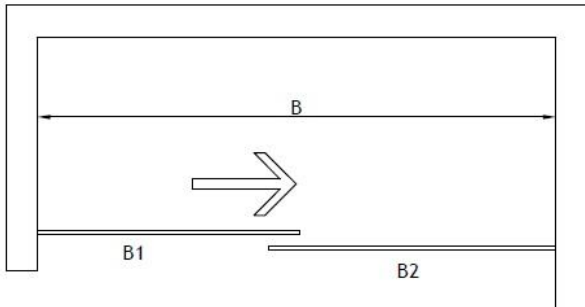
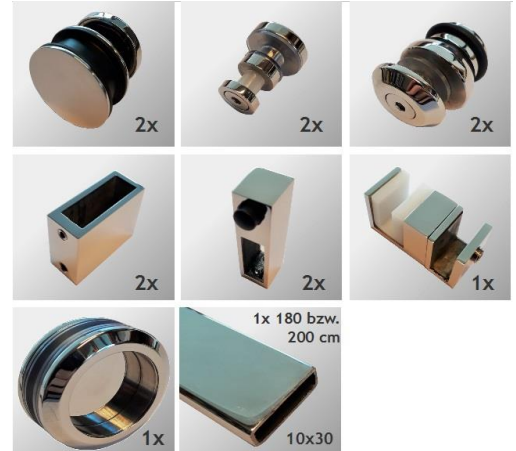

Schiebetür

Fixteil

$$B1 = B/2 - 5$$

$$B2 = B/2 + 50$$

$$B = 1200 \text{ bis } 2000 \text{ mm}$$



SET C2Fix

PC

BL

Artikelnummer	Oberfläche	Laufschiene
S-180 – Set C2Fix PC	Chrom glänzend	1 Stk. L = 1800 mm
S-200 – Set C2Fix PC	Chrom glänzend	1 Stk. L = 2000 mm
S-200 – Set C2Fix BL	Schwarz matt	1 Stk. L = 2000 mm

- Eckdusche mit 2 Fixteilen
- inkl. 1 Paar Griffmuschel SD K07
- für 8 mm bzw. 10 mm Glas

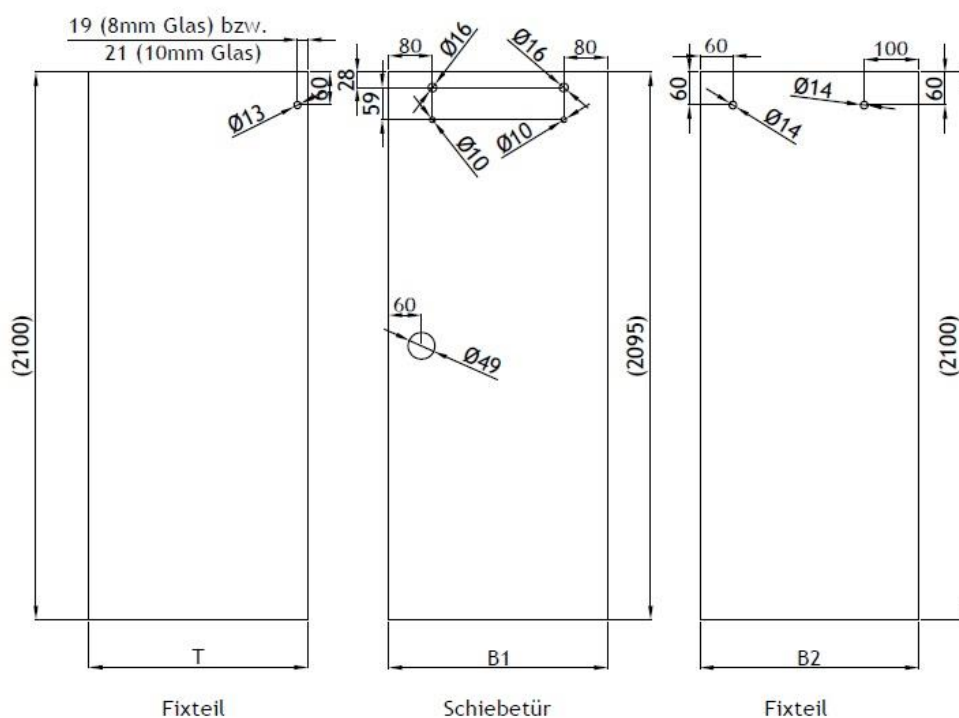
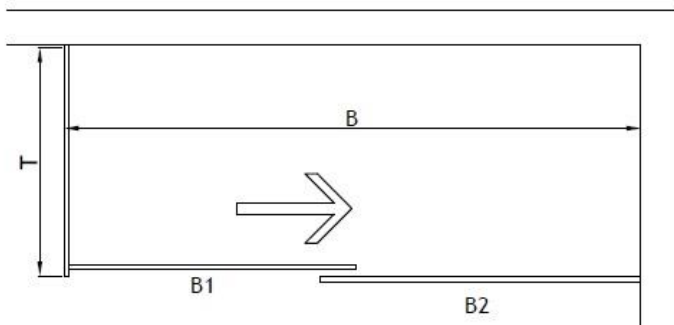
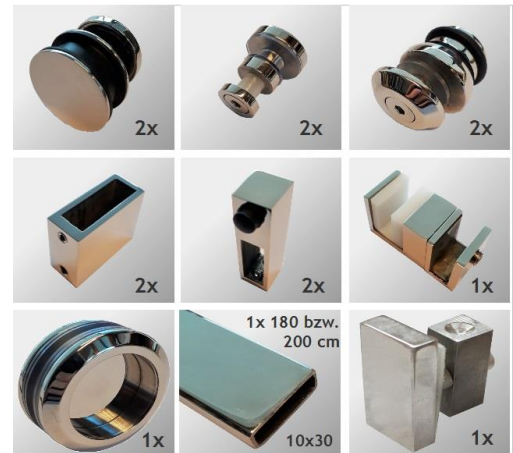
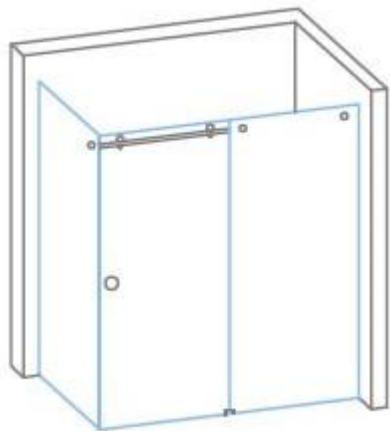

$$BV = B - 5 - (\text{Glasstärke})$$

$$B1 = BV / 2 - 5 \quad B = 1200 \text{ bis } 2000 \text{ mm}$$

$$B2 = BV / 2 + 50$$



SET U

PC BL

Artikelnummer	Oberfläche	Laufschiene
S-180 – Set U PC	Chrom glänzend	1 Stk. L = 1800 mm
S-200 – Set U PC	Chrom glänzend	1 Stk. L = 2000 mm
S-200 – Set U BL	Schwarz matt	1 Stk. L = 2000 mm

- U-Dusche
- inkl. 1 Paar Griffmuschel SD K07
- für 8 mm bzw. 10 mm Glas

1

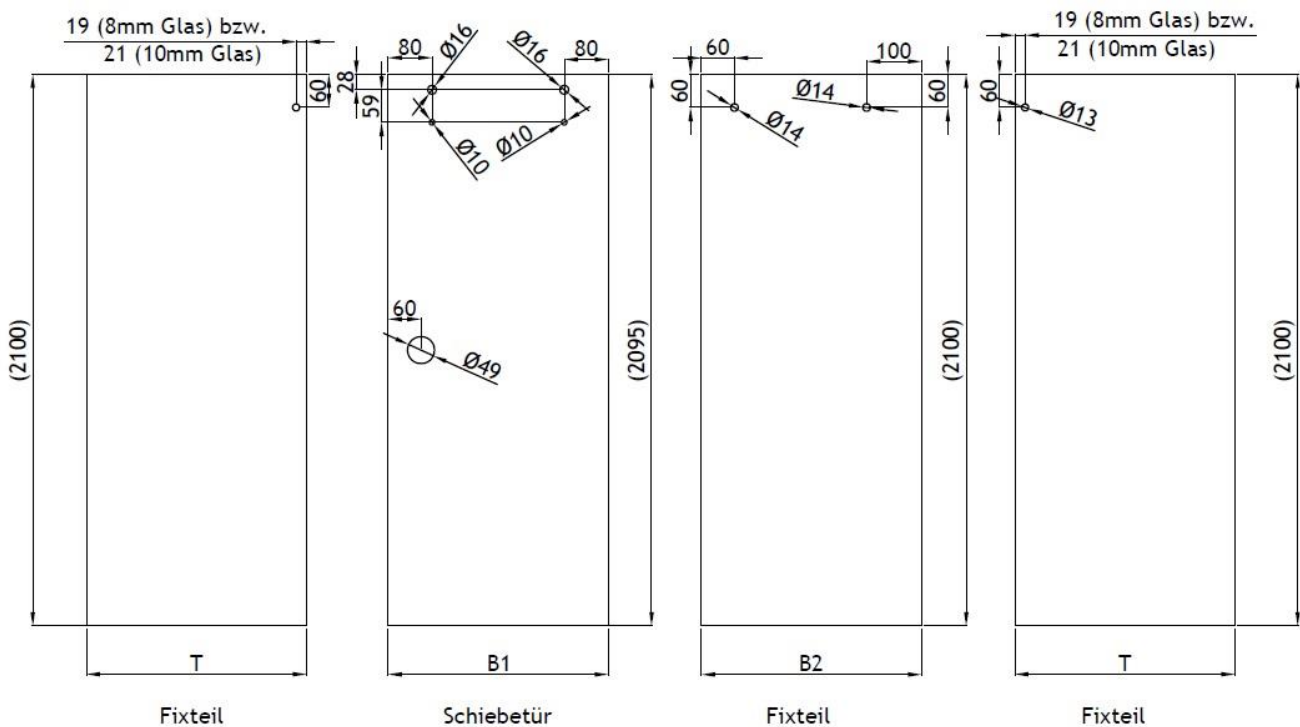
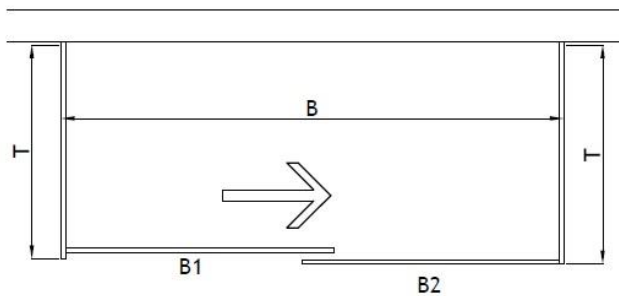
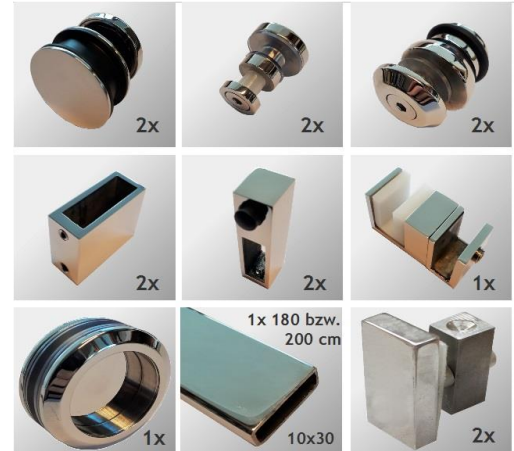
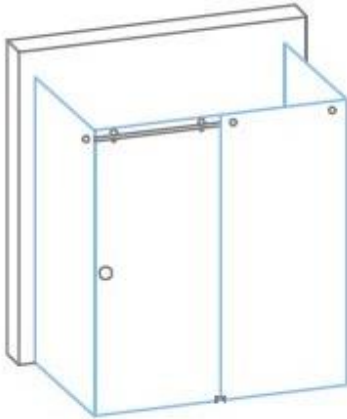

$$BV = B - 2 \times 5 - 2 \times (\text{Glasstärke})$$

$$B1 = BV / 2 - 5 \quad B = 1200 \text{ bis } 2000 \text{ mm}$$

$$B2 = BV / 2 + 50$$



SET C

PC BL

Artikelnummer	Oberfläche	Laufschiene
S-180 – Set C_Typ 1 PC	Chrom glänzend	1 Stk. L = 1800 mm
S-180 – Set C_Typ 2 PC	Chrom glänzend	2 Stk. L = 1800 mm
S-180 – Set C_Typ 2 BL	Schwarz matt	2 Stk. L = 1800 mm
S-200 – Set C PC	Chrom glänzend	1 Stk. L = 2000 mm
S-200 – Set C BL	Schwarz matt	1 Stk. L = 2000 mm

- Eckdusche mit 2 Türen und 2 Fixteilen
- inkl. 2 Paar Griffmuschel SD K07
- für 8 mm bzw. 10 mm Glas

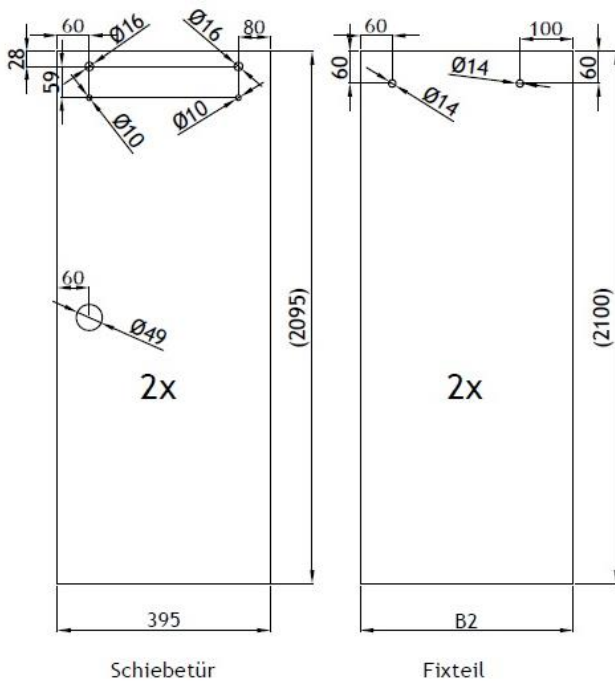
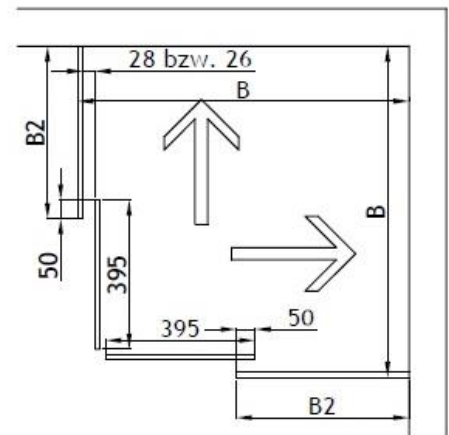
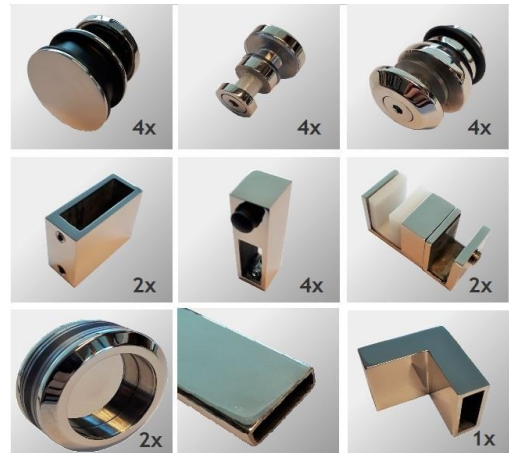
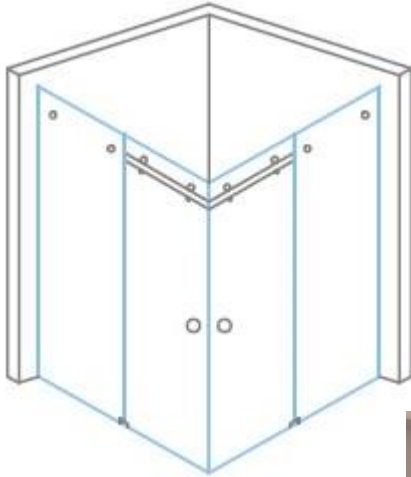

$$B2 = B - 395 - 28 - 16 \text{ bzw. } 20 \text{ (Glasstärke x2)} + 50$$

Beispiel:

$880 - 395 - 28 - 16 + 50 = 491$

z.B. weiterer Abzug von MS 608-4 Magnetdichtung  
 $491 - 12 = 479$

z.B. weiterer Abzug von U19/16/19 U-Profil  
 $479 - 5 = 474$





SET N2Fix

PC

Artikelnummer	Oberfläche	Laufschiene
S-300 – Set N2Fix PC	Chrom glänzend	1 Stk. L = 3000 mm

- Nischendusche mit 2 Fixteilen
- inkl. 1 Paar Griffmuschel SD K07
- für 8 mm bzw. 10 mm Glas

1

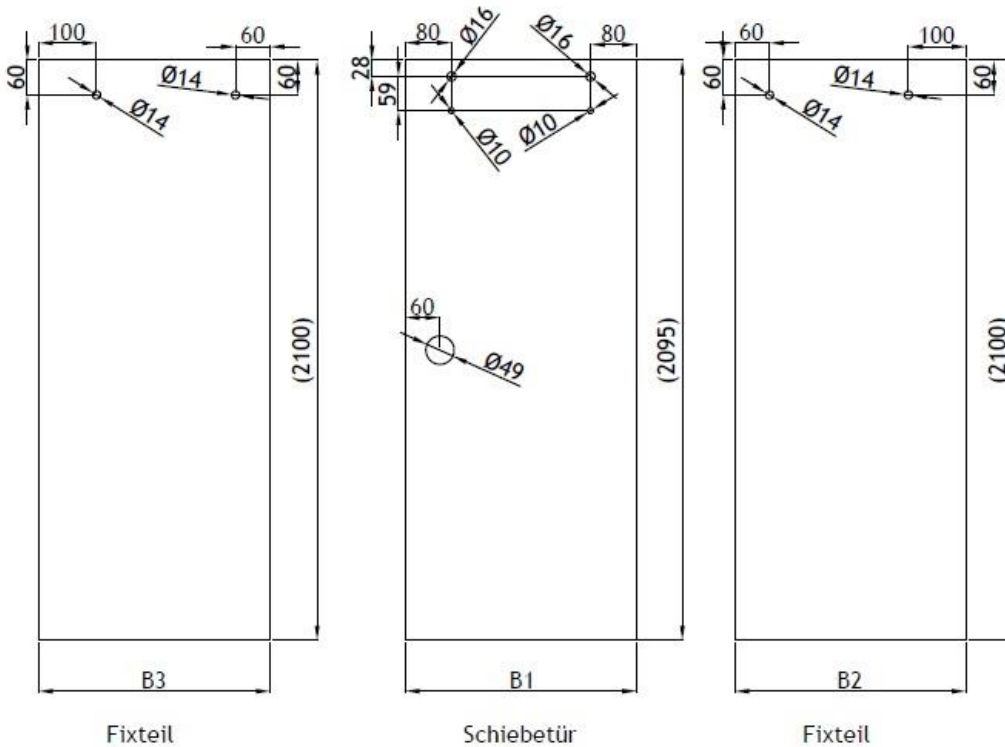
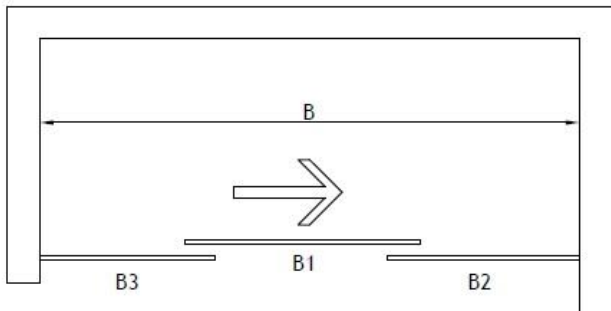
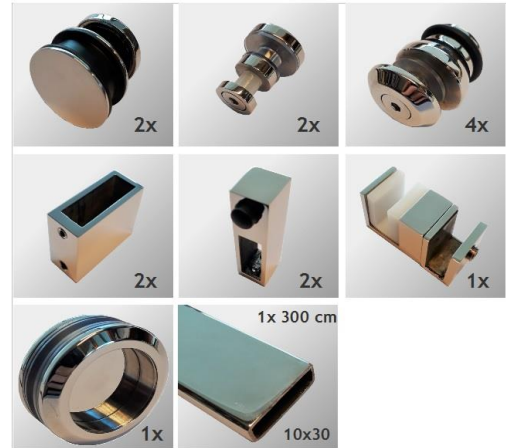
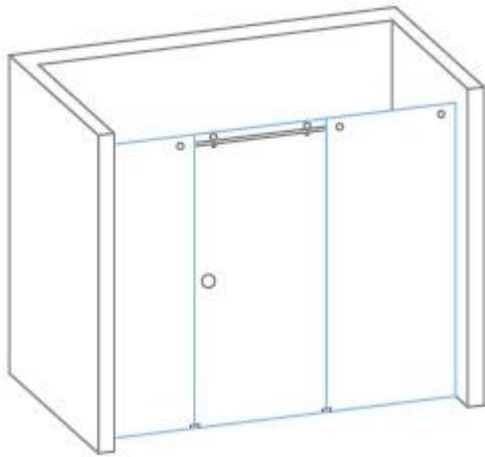

$B1 = \text{max. } 800 \text{ mm}$      $B = \text{bis } 3000 \text{ mm}$   
 $B2 + B3 = (B - B1) / 2 + 40$



SET N2Do2Fix

PC

Artikelnummer	Oberfläche	Laufschiene
S-300 – Set N2Do2Fix PC	Chrom glänzend	1 Stk. L = 3000 mm

- Nischendusche mit 2 Türen und 2 Fixteilen
- inkl. 2 Paar Griffmuschel SD K07
- für 8 mm bzw. 10 mm Glas

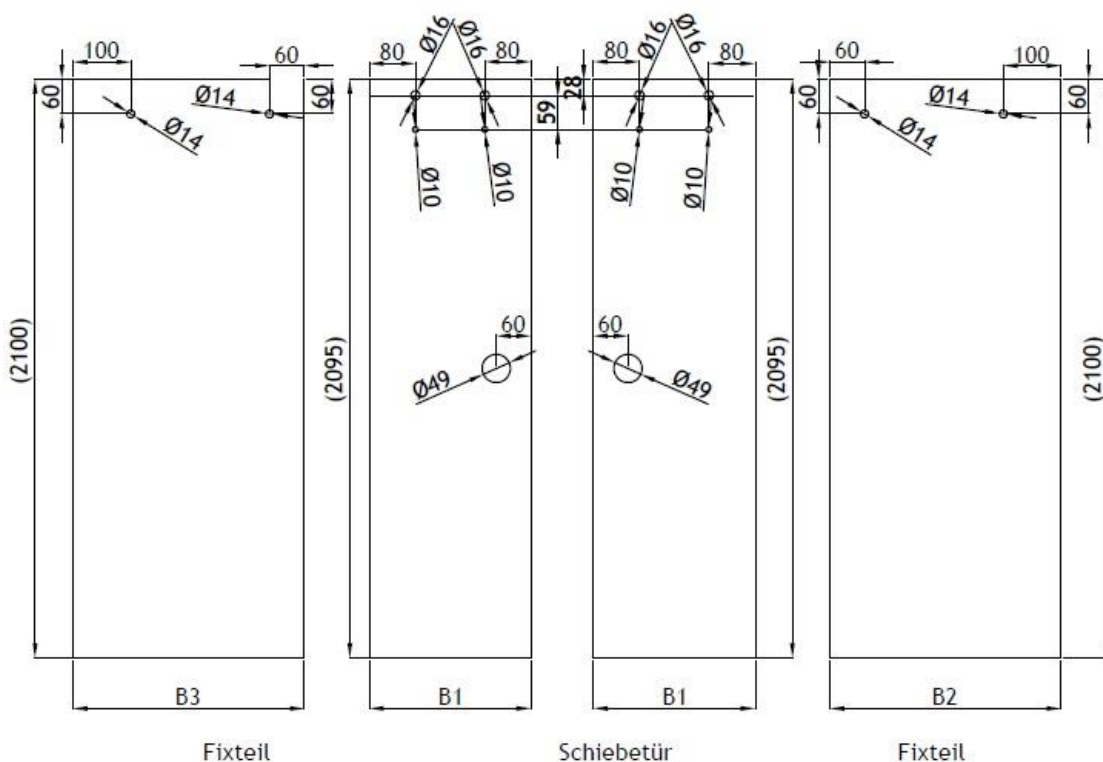
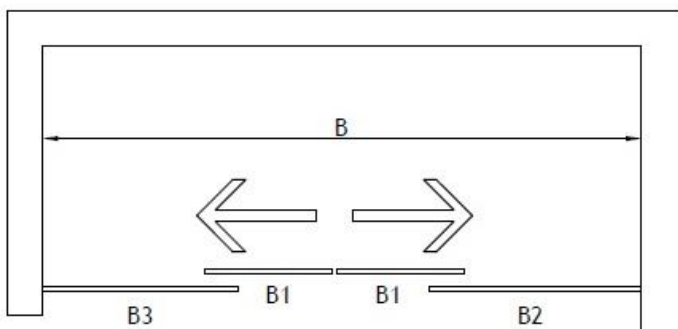
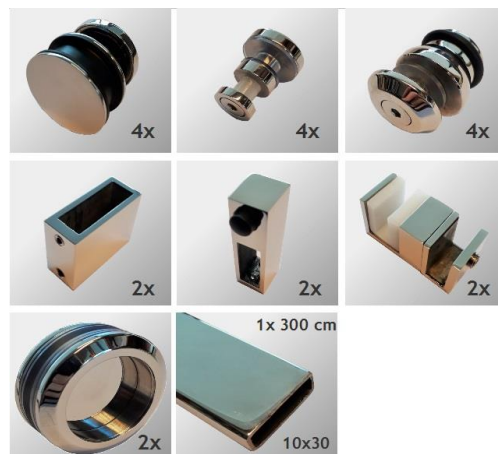
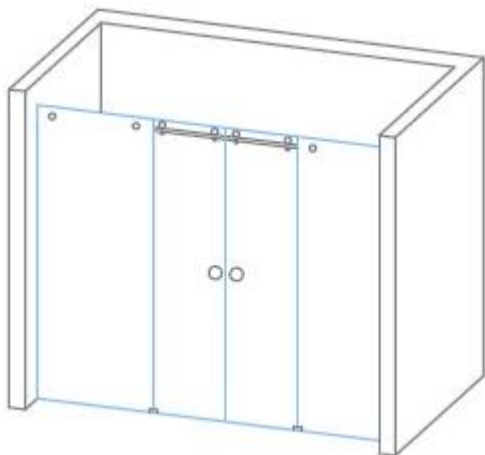

B1 = max. 600 mm    B = bis 3000 mm  
 B2 + B3 = (B - 2 x B1)/2 + 40



## KN-K2

PC BN

Artikelnummer	Oberfläche	Material
KN-K2.PC	Chrom glänzend	Messing
KN-K2.BN	Edelstahl matt	Messing

- Glasbohrung  $\varnothing$  14 mm
- für 8 – 12 mm Glas
- M6-Gewinde

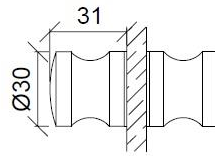

## KN-K2AL

PC BN BL

Artikelnummer	Oberfläche	Material
KN-K2AL.PC	Chrom glänzend	Aluminium
KN-K2AL.BN	Edelstahl matt	Aluminium
KN-K2AL.BL	Schwarz matt	Aluminium

- Glasbohrung  $\varnothing$  14 mm
- für 8 – 12 mm Glas
- M6-Gewinde

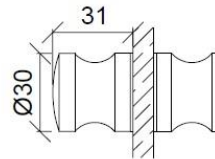

## KS-K2AL

PC

Artikelnummer	Oberfläche	Material
KS-K2AL.PC	Chrom glänzend	Aluminium

- einseitiger Griffknopf
- Glasbohrung  $\varnothing$  14 mm
- für 8 – 12 mm Glas
- M6-Gewinde

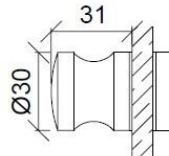

## KN-K4

PC BN

Artikelnummer	Oberfläche	Material
KN-K4.PC	Chrom glänzend	Messing
KN-K4.BN	Edelstahl matt	Messing

- Glasbohrung  $\varnothing$  14 mm
- für 8 – 12 mm Glas
- M6-Gewinde

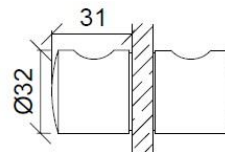

## KN-K4AL

PC BN

Artikelnummer	Oberfläche	Material
KN-K4AL.PC	Chrom glänzend	Aluminium
KN-K4AL.BN	Edelstahl matt	Aluminium

- Glasbohrung  $\varnothing$  14 mm
- für 8 – 12 mm Glas
- M6-Gewinde

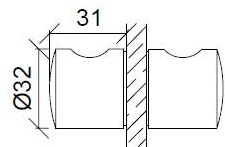

**KN-K5**

SC

Artikelnummer	Oberfläche	Material
KN-K5.SC	Chrom matt	Messing

- Glasbohrung  $\varnothing$  14 mm
- für 8 – 12 mm Glas
- M6-Gewinde

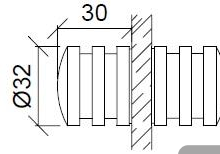

**KN-K6**

PC BN

Artikelnummer	Oberfläche	Material
KN-K6.PC	Chrom glänzend	Messing
KN-K6.BN	Edelstahl matt	Messing

- Glasbohrung  $\varnothing$  10 mm
- für 8 – 12 mm Glas
- M6-Gewinde
- mit Wurmschraube zur Fixierung

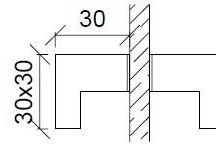

**KN-K7**

PC BN

Artikelnummer	Oberfläche	Material
KN-K7.PC	Chrom glänzend	Messing
KN-K7.BN	Edelstahl matt	Messing

- Glasbohrung  $\varnothing$  10 mm
- für 8 – 12 mm Glas
- M6-Gewinde
- mit Wurmschraube zur Fixierung

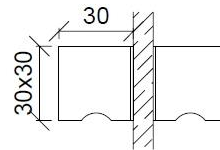

**KN-307**

PC BN

Artikelnummer	Oberfläche	Material
KN-307.PC	Chrom glänzend	Messing
KN-307.BN	Edelstahl matt	Messing

- Glasbohrung  $\varnothing$  14 mm
- für 8 – 12 mm Glas
- M6-Gewinde

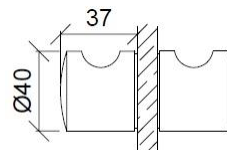

**KN-308**

PC BN

Artikelnummer	Oberfläche	Material
KN-308.PC	Chrom glänzend	Messing
KN-308.BN	Edelstahl matt	Messing

- Glasbohrung  $\varnothing$  14 mm
- für 8 – 12 mm Glas
- M6-Gewinde

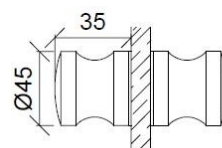

## BLD-G2Z

Artikelnummer	Oberfläche
BLD-G2Z.PC	Chrom glänzend
BLD-G2Z.BN	Edelstahl matt

PC BN

- Glas/Wand, 90°
- für 8 – 10 mm Glas

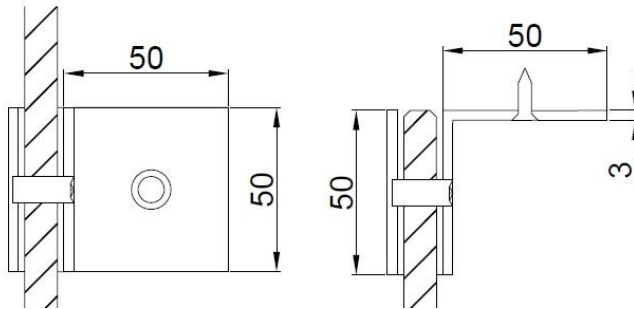

Glas Cut-Out

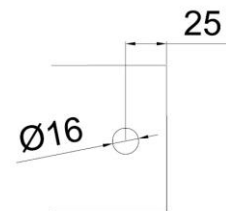

## BLD-G3Z

Artikelnummer	Oberfläche
BLD-G3Z.PC	Chrom glänzend
BLD-G3Z.BN	Edelstahl matt

PC BN

- Glas/Wand, 180°
- für 8 – 10 mm Glas

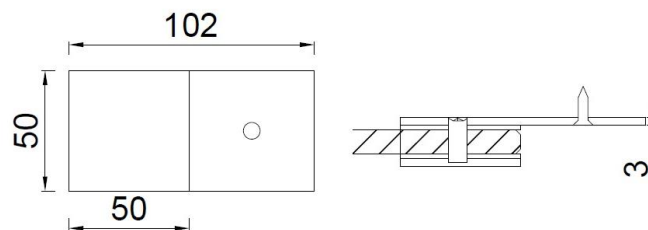

Glas Cut-Out

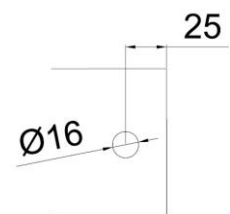

## BLD-G4Z

Artikelnummer	Oberfläche
BLD-G4Z.PC	Chrom glänzend
BLD-G4Z.BN	Edelstahl matt

PC BN

- Glas/Glas, 180°
- für 8 – 10 mm Glas

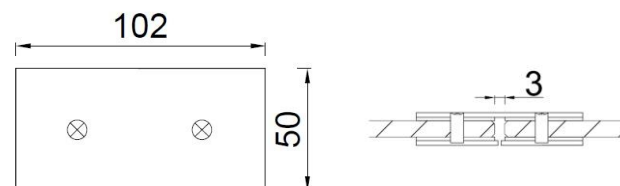

Glas Cut-Out

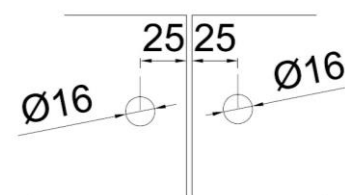

### BLD-G5Z

PC BN

Artikelnummer	Oberfläche
BLD-G5Z.PC	Chrom glänzend
BLD-G5Z.BN	Edelstahl matt

- Glas/Glas, 90°  
- für 8 – 10 mm Glas

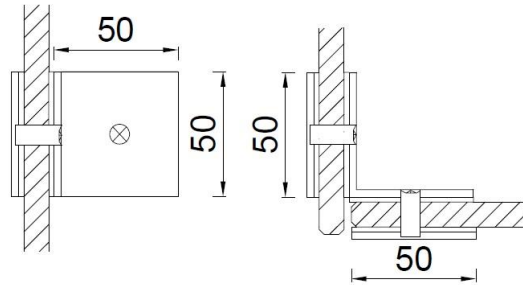

Glas Cut-Out

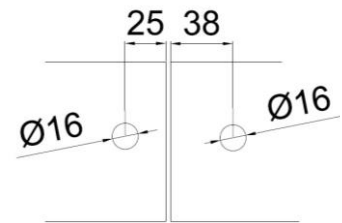

### BLD-G6Z

PC BN

Artikelnummer	Oberfläche
BLD-G6Z.PC	Chrom glänzend
BLD-G6Z.BN	Edelstahl matt

- Glas/Glas, 135°  
- für 8 – 10 mm Glas

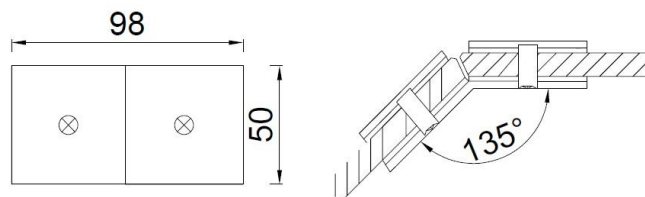

Glas Cut-Out

Gehrung 2x 22.5°  
oder 90° Glaskante

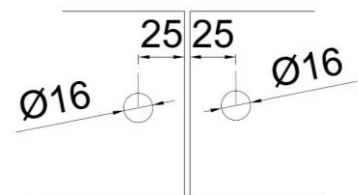

## GC-GG90

Artikelnummer	Oberfläche
GC-GG90.PC	Chrom glänzend
GC-GG90.BN	Edelstahl matt
GC-GG90.BL	Schwarz matt

PC BN BL

- Glas/Glas, 90°
- für 8 – 12 mm Glas

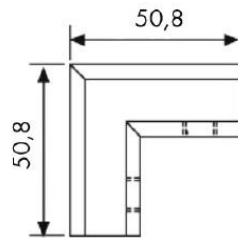

## GC-GG135

Artikelnummer	Oberfläche
GC-GG135.PC	Chrom glänzend
GC-GG135.BN	Edelstahl matt
GC-GG135.BL	Schwarz matt

PC BN BL

- Glas/Glas, 135°
- für 8 – 12 mm Glas

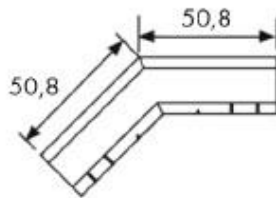

## GC-GW-L

Artikelnummer	Oberfläche
GC-GW-L.PC	Chrom glänzend
GC-GW-L.BN	Edelstahl matt
GC-GW-L.BL	Schwarz matt

PC BN BL

- Glas/Wand, 90°, links
- für 8 – 12 mm Glas

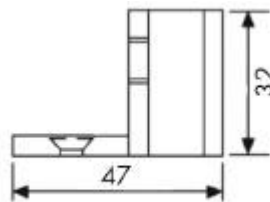

## GC-GW-R

Artikelnummer	Oberfläche
GC-GW-R.PC	Chrom glänzend
GC-GW-R.BN	Edelstahl matt
GC-GW-R.BL	Schwarz matt

PC BN BL

- Glas/Wand, 90°, rechts
- für 8 – 12 mm Glas

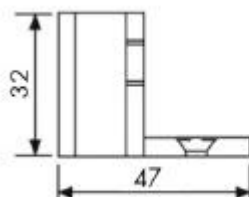

## SBA19-Set Glas/Wand

PC BN

Artikelnummer	Oberfläche	bestehend aus
SBA19-Set Glas/Wand, 90° PC L = 1300 mm	Chrom glänzend	1 Stk. SBA19-Stange PC, L = 1300 mm 1 Stk. SBA19-W90.PC 1 Stk. SBA19-CL1.PC
SBA19-Set Glas/Wand, 90° BN L = 1300 mm	Edelstahl matt	1 Stk. SBA19-Stange BN, L = 1000 mm 1 Stk. SBA19-W90.BN 1 Stk. SBA19-CL1.BN
SBA19-Set Glas/Wand, 90° PC L = 1000 mm	Chrom glänzend	1 Stk. SBA19-Stange PC, L = 1000 mm 1 Stk. SBA19-W90.PC 1 Stk. SBA19-CL1.PC
SBA19-Set Glas/Wand, 45° PC L = 500 mm	Chrom glänzend	1 Stk. SBA19-Stange PC, L = 500 mm 1 Stk. SBA19-W45.PC 1 Stk. SBA19-CL1.PC

- Rohr Ø 19 mm  
- für 8 – 12 mm Glas



## SBA19-W90

PC BN

Artikelnummer	Oberfläche
SBA19-W90.PC	Chrom glänzend
SBA19-W90.BN	Edelstahl matt

- Wandanschluss 90°  
- für Rohr Ø 19 mm  
- für 8 – 12 mm Glas

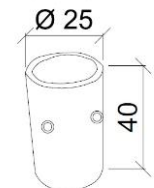

## SBA19-W45

PC BN

Artikelnummer	Oberfläche
SBA19-W45.PC	Chrom glänzend
SBA19-W45.BN	Edelstahl matt

- Wandanschluss 45°  
- für Rohr Ø 19 mm  
- für 8 – 12 mm Glas

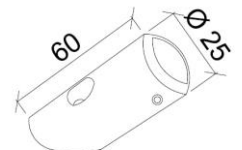

## SBA19-CL1

PC BN

Artikelnummer	Oberfläche
SBA19-CL1.PC	Chrom glänzend
SBA19-CL1.BN	Edelstahl matt

- Glashalter geschlossen, beweglich  
- für Rohr Ø 19 mm  
- für 8 – 12 mm Glas

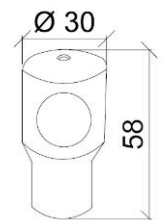

## SBA19-CL2

PC BN

Artikelnummer	Oberfläche
SBA19-CL2.PC	Chrom glänzend
SBA19-CL2.BN	Edelstahl matt

- Glashalter offen, beweglich  
- für Rohr Ø 19 mm  
- für 8 – 12 mm Glas

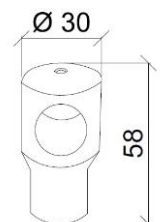



### SBA19-T

Artikelnummer	Oberfläche
SBA19-T.PC	Chrom glänzend
SBA19-T.BN	Edelstahl matt

PC BN

- T-Verbinder
- für Rohr Ø 19 mm
- für 8 – 12 mm Glas



### SBA19-L

Artikelnummer	Oberfläche
SBA19-L.PC	Chrom glänzend
SBA19-L.BN	Edelstahl matt

PC BN

- L-Verbindung, beweglich
- für Rohr Ø 19 mm
- für 8 – 12 mm Glas



### SBA19-C

Artikelnummer	Oberfläche
SBA19-C.PC	Chrom glänzend
SBA19-C.BN	Edelstahl matt

PC BN

- Ecke 90°
- für Rohr Ø 19 mm
- für 8 – 12 mm Glas

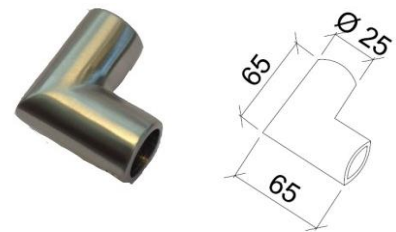

### SBA19-I

Artikelnummer	Oberfläche
SBA19-I.PC	Chrom glänzend
SBA19-I.BN	Edelstahl matt

PC BN

- Verbindungsstück 180°
- für Rohr Ø 19 mm
- für 8 – 12 mm Glas



### SBA19-Stange

Artikelnummer	Oberfläche	Länge
SBA19-Stange PC, L = 2000 mm	Chrom glänzend	2000 mm
SBA19-Stange BN, L = 2000 mm	Edelstahl matt	2000 mm

PC BN

- Rohr Ø 19 mm



### SBA16-Set Glas/Wand

PC BN **BL**

Artikelnummer	Oberfläche	bestehend aus
SBA16-Set Glas/Wand, 90° PC L = 1300 mm	Chrom glänzend	1 Stk. SBA16-Stange PC, L = 1300 mm 1 Stk. SBA16-W90.PC 1 Stk. SBA16-CL-ADJ.PC
SBA16-Set Glas/Wand, 90° PC L = 1000 mm	Chrom glänzend	1 Stk. SBA16-Stange PC, L = 1000 mm 1 Stk. SBA16-W90.PC 1 Stk. SBA16-CL-ADJ.PC
SBA16-Set Glas/Wand, 90° BN L = 1000 mm	Edelstahl matt	1 Stk. SBA16-Stange BN, L = 1000 mm 1 Stk. SBA16-W90.BN 1 Stk. SBA16-CL-ADJ.BN
SBA16-Set Glas/Wand, 90° BL L = 1300 mm	Schwarz matt	1 Stk. SBA16-Stange BL, L = 1300 mm 1 Stk. SBA16-W90.BL 1 Stk. SBA16-CL-ADJ.BL
SBA16-Set Glas/Wand, 90° BL L = 1000 mm	Schwarz matt	1 Stk. SBA16-Stange BL, L = 1000 mm 1 Stk. SBA16-W90.BL 1 Stk. SBA16-CL-ADJ.BL

- Rohr Ø 16 mm  
- für 8 – 10 mm Glas



### SBA16-W90

PC BN **BL**

Artikelnummer	Oberfläche
SBA16-W90.PC	Chrom glänzend
SBA16-W90.BN	Edelstahl matt
SBA16-W90.BL	Schwarz matt

- Wandanschluss 90°  
- für Rohr Ø 16 mm  
- für 8 – 10 mm Glas



### SBA16-W45

PC BN **BL**

Artikelnummer	Oberfläche
SBA16-W45.PC	Chrom glänzend
SBA16-W45.BN	Edelstahl matt
SBA16-W45.BL	Schwarz matt

- Wandanschluss 45°  
- für Rohr Ø 16 mm  
- für 8 – 10 mm Glas

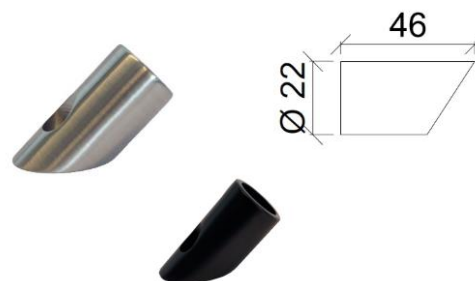

### SBA16-CL-ADJ

PC BN **BL**

Artikelnummer	Oberfläche
SBA16-CL-ADJ.PC	Chrom glänzend
SBA16-CL-ADJ.BN	Edelstahl matt
SBA16-CL-ADJ.BL	Schwarz matt

- Glasanschluss geschlossen,  
beweglich  
- für Rohr Ø 16 mm  
- für 8 – 10 mm Glas

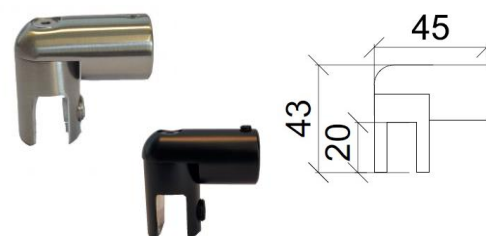

### SBA16-T

Artikelnummer	Oberfläche
SBA16-T.PC	Chrom glänzend
SBA16-T.BN	Edelstahl matt
SBA16-T.BL	Schwarz matt

PC BN BL

- T-Verbinder
- für Rohr Ø 16 mm
- für 8 – 10 mm Glas

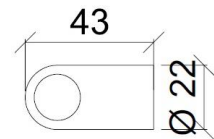

1

### SBA16-CL

Artikelnummer	Oberfläche
SBA16-CL.PC	Chrom glänzend
SBA16-CL.BN	Edelstahl matt

PC BN

- Glasanschluss offen, beweglich
- für Rohr Ø 16 mm
- für 8 – 10 mm Glas

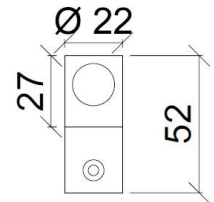

### SBA16-CL-C

Artikelnummer	Oberfläche
SBA16-CL-C.PC	Chrom glänzend
SBA16-CL-C.BN	Edelstahl matt

PC BN

- Glasanschluss für Deckenbefestigung
- für Rohr Ø 16 mm
- für 8 – 10 mm Glas

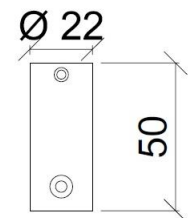

### SBA16-C90

Artikelnummer	Oberfläche
SBA16-C90.PC	Chrom glänzend
SBA16-C90.BN	Edelstahl matt

PC BN

- Ecke 90°
- für Rohr Ø 16 mm
- für 8 – 10 mm Glas

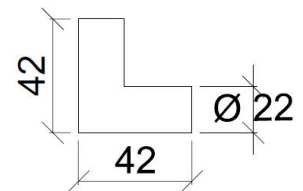

### SBA16-W-ADJ

Artikelnummer	Oberfläche
SBA16-W-ADJ.PC	Chrom glänzend
SBA16-W-ADJ.BN	Edelstahl matt
SBA16-W-ADJ.BL	Schwarz matt

PC BN BL

- Wandanschluss, beweglich
- für Rohr Ø 16 mm
- für 8 – 10 mm Glas

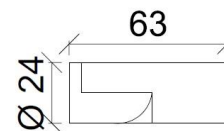

### SBA16-Stange

Artikelnummer	Oberfläche	Länge
SBA16-Stange PC, L = 1000 mm	Chrom glänzend	1000 mm
SBA16-Stange PC, L = 1500 mm	Chrom glänzend	1500 mm
SBA16-Stange BN, L = 1500 mm	Edelstahl matt	1500 mm
SBA16-Stange PC, L = 2000 mm	Chrom glänzend	2000 mm
SBA16-Stange BN, L = 2000 mm	Edelstahl matt	2000 mm
SBA16-Stange BL, L = 2000 mm	Schwarz matt	2000 mm

PC BN BL

- Rohr Ø 16 mm



**SBA-S-Set Glas/Wand**

PC BL

Artikelnummer	Oberfläche	bestehend aus
SBA-S-Set eckig Glas/Wand, 90° PC L = 1500 mm	Chrom glänzend	1 Stk. SBA-S-Stange PC, L = 1500 mm 1 Stk. SBA-S-W90.PC 1 Stk. SBA-S-CL-ADJ.PC
SBA-S-Set eckig Glas/Wand, 90° BL L = 1300 mm	Schwarz matt	1 Stk. SBA-S-Stange BL, L = 1300 mm 1 Stk. SBA-S-W90.BL 1 Stk. SBA-S-CL-ADJ.BL

- Formrohr 19 x 19 mm  
- für 8 – 10 mm Glas



**SBA-S-W90**

PC

Artikelnummer	Oberfläche
SBA-S-W90.PC	Chrom glänzend

- Wandanschluss 90°  
- für 19 x 19 mm  
- für 8 – 10 mm Glas

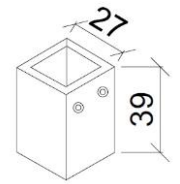

**SBA-S-W22,5**

PC

Artikelnummer	Oberfläche
SBA-S-W22,5.PC	Chrom glänzend

- Wandanschluss 22,5°  
- für 19 x 19 mm  
- für 8 – 10 mm Glas

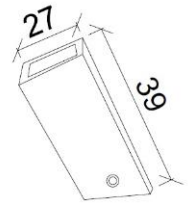

**SBA-S-W45**

PC

Artikelnummer	Oberfläche
SBA-S-W45.PC	Chrom glänzend

- Wandanschluss 45°  
- für 19 x 19 mm  
- für 8 – 10 mm Glas

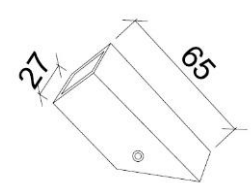

**SBA-S-W-ADJ**

PC BL

Artikelnummer	Oberfläche
SBA-S-W-ADJ.PC	Chrom glänzend
SBA-S-W-ADJ.BL	Schwarz matt

- Wandanschluss, beweglich  
- für 19 x 19 mm  
- für 8 – 10 mm Glas

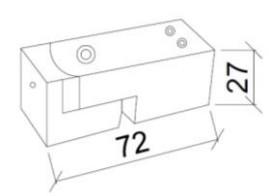

### SBA-S-CL-ADJ

Artikelnummer	Oberfläche
SBA-S-CL-ADJ.PC	Chrom glänzend
SBA-S-CL-ADJ.BL	Schwarz matt

PC BL

- Glasanschluss geschlossen, beweglich
- für 19 x 19 mm
- für 8 – 10 mm Glas

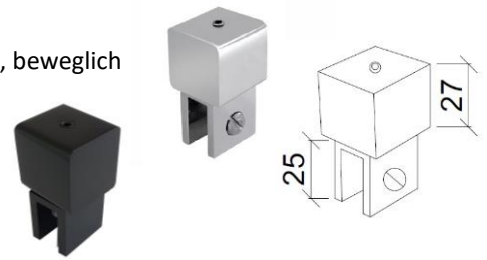

1

### SBA-S-CL-ADJ-2

Artikelnummer	Oberfläche
SBA-S-CL-ADJ-2.PC	Chrom glänzend

PC

- Glasanschluss offen, beweglich
- für 19 x 19 mm
- für 8 – 10 mm Glas

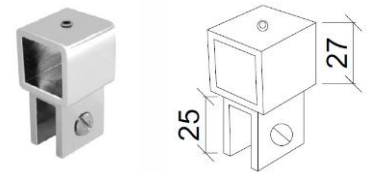

### SBA-S-CL90

Artikelnummer	Oberfläche
SBA-S-CL90.PC	Chrom glänzend

PC

- Glashalter geschlossen, nicht beweglich
- für 19 x 19 mm
- für 8 – 10 mm Glas

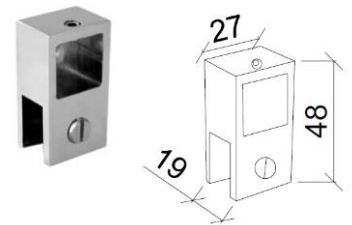

### SBA-S-T

Artikelnummer	Oberfläche
SBA-S-T.PC	Chrom glänzend
SBA-S-T.BL	Schwarz matt

PC BL

- T-Verbindung
- für 19 x 19 mm
- für 8 – 10 mm Glas

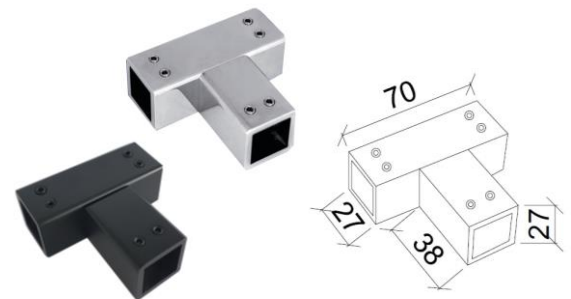

### SBA-S-L

Artikelnummer	Oberfläche
SBA-S-L.PC	Chrom glänzend

PC

- Verbindungsstück, beweglich
- für 19 x 19 mm
- für 8 – 10 mm Glas

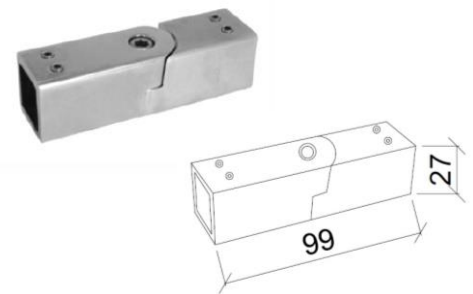

### SBA-S-Stange

Artikelnummer	Oberfläche	Länge
SBA-S-Stange PC, L = 1500 mm	Chrom glänzend	1500 mm
SBA-S-Stange BL, L = 1300 mm	Schwarz matt	1300 mm

PC BL

- Formrohr 19 x 19 mm

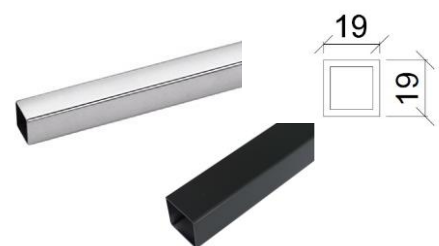

**SBA-G-Set**

PC

Artikelnummer	Oberfläche	bestehend aus
SBA-G-Set Glas/Wand PC	Chrom glänzend	1 Stk. ESG Float 8 mm, Kanten poliert 1 Stk. SBA-G-W 1 Stk. SBA-G-G
SBA-G-Set Glas/Glas PC	Chrom glänzend	1 Stk. ESG Float 8 mm, Kanten poliert 2 Stk. SBA-G-G
SBA-G-Set Glas/Wand, Optiwhite PC	Chrom glänzend	1 Stk. ESG Float extraweiß 8 mm, Kanten poliert 1 Stk. SBA-G-W 1 Stk. SBA-G-G
SBA-G-Set Glas/Glas, Optiwhite PC	Chrom glänzend	1 Stk. ESG Float extraweiß 8 mm, Kanten poliert 2 Stk. SBA-G-G

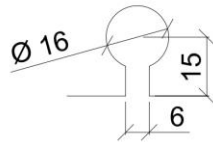
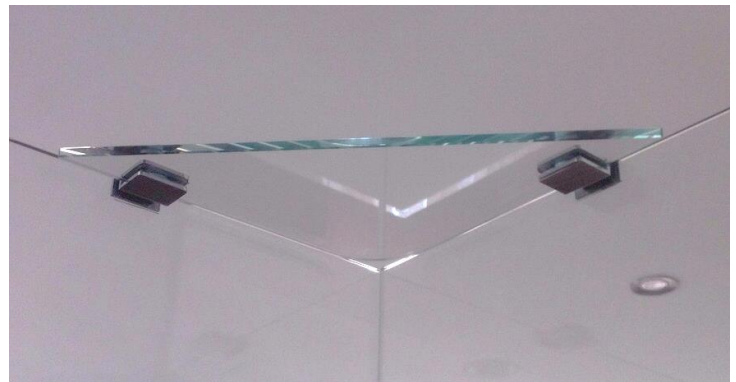
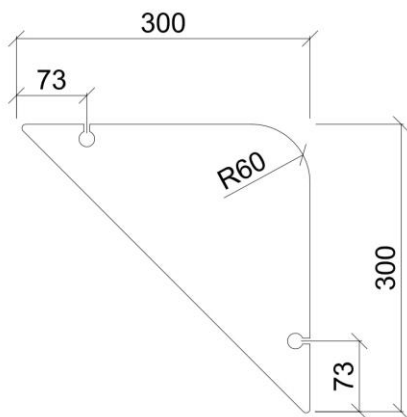

**SBA-G-W**

PC

Artikelnummer	Oberfläche
SBA-G-W.PC	Chrom glänzend

- Glas/Wand
- für 8 mm Glas

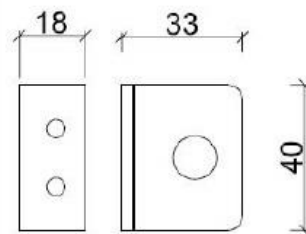
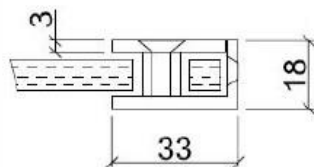

**SBA-G-G**

PC

Artikelnummer	Oberfläche
SBA-G-G.PC	Chrom glänzend

- Glas/Glas
- für 8 mm Glas

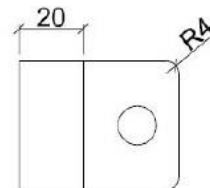
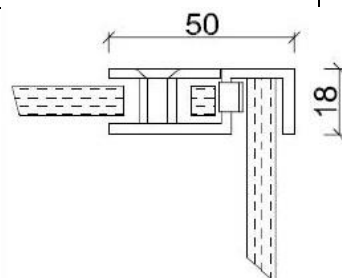

SP 701

PC BN

Artikelnummer	Oberfläche	Länge / Bohrabstand
SP 701.PC	Chrom glänzend	222 mm / 203 mm
SP 701.BN	Edelstahl matt	222 mm / 203 mm

- Ø 19 mm
- Glasbohrung Ø 14 mm
- für 8 – 12 mm Glas

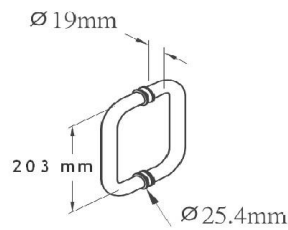

SP 702

PC BN

Artikelnummer	Oberfläche	Bohrabstand
SP 702.PC	Chrom glänzend	203 + 457 mm
SP 702.BN	Edelstahl matt	203 + 457 mm

- Ø 19 mm
- Glasbohrung Ø 14 mm
- für 8 – 12 mm Glas

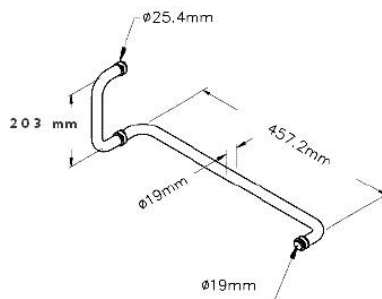

TB 701

PC BN

Artikelnummer	Oberfläche	Länge / Bohrabstand
TB 701.PC	Chrom glänzend	628 mm / 609 mm
TB 701.BN	Edelstahl matt	628 mm / 609 mm

- Ø 19 mm
- Glasbohrung Ø 14 mm
- für 8 – 12 mm Glas

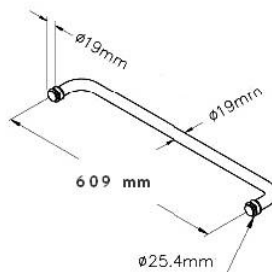

TB 702

PC BN

Artikelnummer	Oberfläche	Länge / Bohrabstand
TB 702.PC	Chrom glänzend	628 mm / 609 mm
TB 702.BN	Edelstahl matt	628 mm / 609 mm

- Ø 19 mm
- Glasbohrung Ø 14 mm
- für 8 – 12 mm Glas

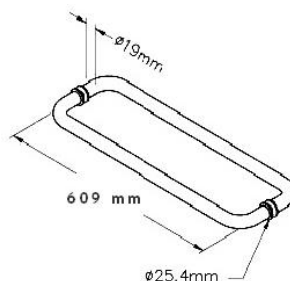

### TB 800

PC

Artikelnummer	Oberfläche	Länge / Bohrabstand
TB 800-457.PC	Chrom glänzend	476 mm / 457 mm
TB 800-610.PC	Chrom glänzend	629 mm / 610 mm

- 19 x 19 mm
- Glasbohrung Ø 10 mm
- für 8 – 12 mm Glas



### TB 801

PC

Artikelnummer	Oberfläche	Länge / Bohrabstand
TB 801-457.PC	Chrom glänzend	476 mm / 457 mm
TB 801-610.PC	Chrom glänzend	629 mm / 610 mm

- 19 x 19 mm
- Glasbohrung Ø 10 mm
- für 8 – 12 mm Glas



### SP 800

PC

BN

BL

Artikelnummer	Oberfläche	Länge / Bohrabstand
SP 800-610.BN	Edelstahl matt	629 mm / 610 mm
SP 800-305.PC	Chrom glänzend	324 mm / 305 mm
SP 800-305.BN	Edelstahl matt	324 mm / 305 mm
SP 800-305.BL	Schwarz matt	324 mm / 305 mm

- 19 x 19 mm
- Glasbohrung Ø 10 mm
- für 8 – 12 mm Glas





### U19/16/19

PC

Artikelnummer	Oberfläche	Länge
U19/16/19.PC L = 2490 mm	Chrom glänzend	2490 mm

- Material: Aluminium



1

### P-027

PC

Artikelnummer	Oberfläche	Länge
P-027.PC L = 2200 mm	Chrom glänzend	2200 mm

- Vertikales Rahmensystem  
- für 8 mm Glas

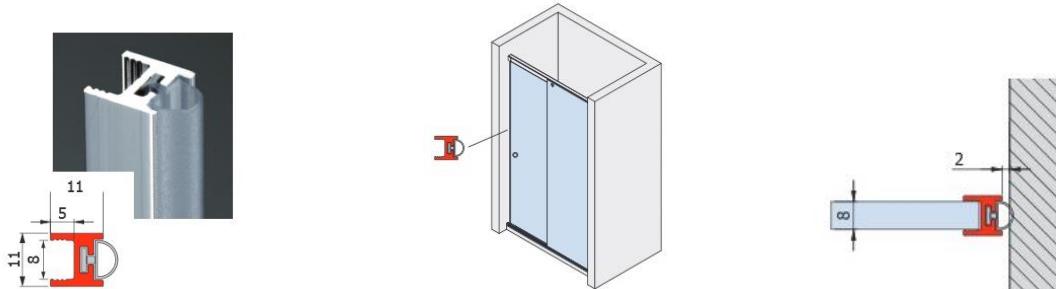

### P-016

PC

Artikelnummer	Oberfläche	Länge
P-016.PC L = 2200 mm	Chrom glänzend	2200 mm

- Vertikales Rahmenprofil  
für magnetische Zuhaltung  
- für 8 mm Glas

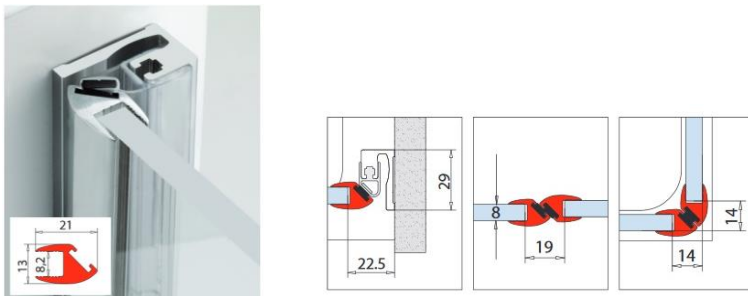

### P-019

PC

Artikelnummer	Oberfläche	Länge
P-019.PC L = 2200 mm	Chrom glänzend	2200 mm

- Schallschutz-Profil mit  
PVC-Dichtung  
- für 8 mm Glas

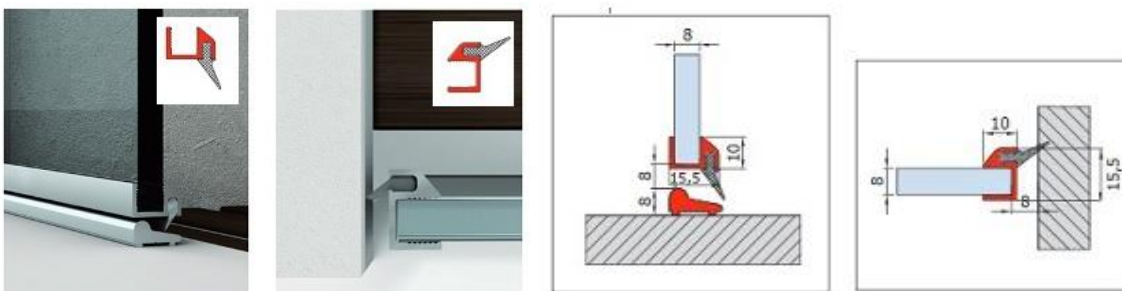

**P-018-M**

PC

Artikelnummer	Oberfläche	Länge
P-018-M.PC L = 2200 mm	Chrom glänzend	2200 mm

- Türanschlagsprofil mit Magnetdichtung
- für 8 mm Glas

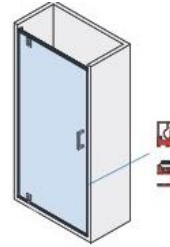
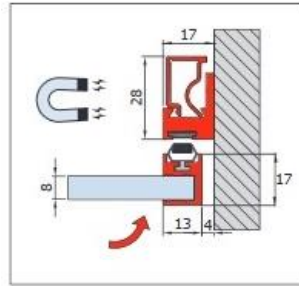

**P-018-B**

PC

Artikelnummer	Oberfläche	Länge
P-018-B.PC L = 2500 mm	Chrom glänzend	2500 mm

- Vertikales Rahmenprofil mit Magnet
- für 8 mm Glas

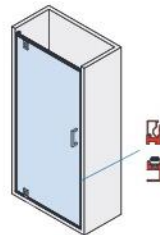
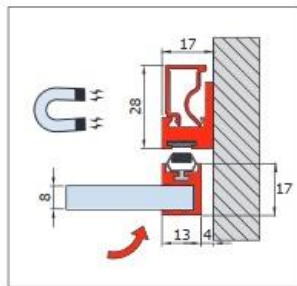

**P-018-V**

PC

Artikelnummer	Oberfläche	Länge
P-018-V.PC L = 2500 mm	Chrom glänzend	2500 mm

- Türanschlagsprofil für Glasmontage
- für 8 mm Glas

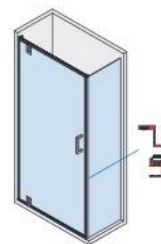
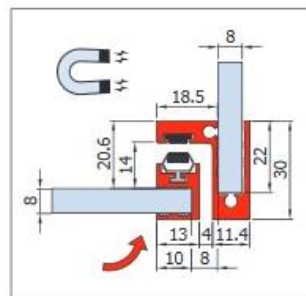

## SG-Round

PC

Artikelnummer	Oberfläche	Länge
SG-Round.PC L = 2000 mm	Chrom glänzend	2000 mm

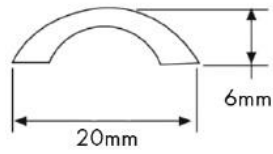

1

## SG-Wave

PC

BN

WH

Artikelnummer	Oberfläche	Länge
SG-Wave.PC L = 2000 mm	Chrom glänzend	2000 mm
SG-Wave.PC L = 833 mm	Chrom glänzend	833 mm
SG-Wave.BN L = 2000 mm	Edelstahl matt	2000 mm
SG-Wave.WH L = 1990mm	RAL 9016 weiß matt	1990 mm

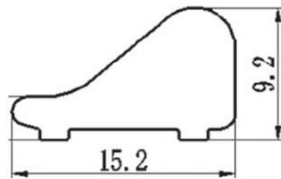

### WS F1

Artikelnummer	für Glasstärke	Länge
WS F1 für 8 mm Glas, L = 2000 mm	6 – 8 mm	2000 mm
WS F1 für 8 mm Glas, L = 2500 mm	6 – 8 mm	2500 mm
WS F1 für 10 mm Glas, L = 2500 mm	10 mm	2500 mm

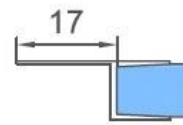

### WS F4

Artikelnummer	für Glasstärke	Länge
WS F4 für 8 mm Glas, L = 2000 mm	6 – 8 mm	2000 mm
WS F4 für 8 mm Glas, L = 2500 mm	6 – 8 mm	2500 mm
WS F4 für 10 mm Glas, L = 2500 mm	10 mm	2500 mm

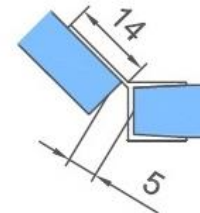

### WS F5

Artikelnummer	für Glasstärke	Länge
WS F5 für 8 mm Glas, L = 833 mm	6 – 8 mm	833 mm
WS F5 für 8 mm Glas, L = 2000 mm	6 – 8 mm	2000 mm
WS F5 für 8 mm Glas, L = 2500 mm	6 – 8 mm	2500 mm
WS F5 für 10 mm Glas, L = 2500 mm	10 mm	2500 mm

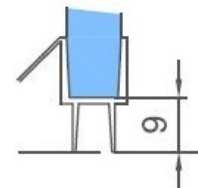

### WS F6

Artikelnummer	für Glasstärke	Länge
WS F6 für 8 mm Glas, L = 2000 mm	6 – 8 mm	2000 mm
WS F6 für 8 mm Glas, L = 2500 mm	6 – 8 mm	2500 mm
WS F6 für 10 mm Glas, L = 2500 mm	10 mm	2500 mm

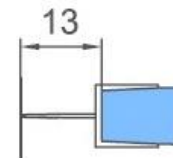

### WS F7

Artikelnummer	für Glasstärke	Länge
WS F7 für 8 mm Glas, L = 2000 mm	6 – 8 mm	2000 mm
WS F7 für 8 mm Glas, L = 2500 mm	6 – 8 mm	2500 mm
WS F7 für 10 mm Glas, L = 2500 mm	10 mm	2500 mm

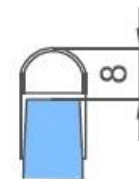

### WS F8

Artikelnummer	für Glasstärke	Länge
WS F8 für 8 mm Glas, L = 2000 mm	6 – 8 mm	2000 mm
WS F8 für 8 mm Glas, L = 2500 mm	6 – 8 mm	2500 mm
WS F8 für 10 mm Glas, L = 2500 mm	10 mm	2500 mm

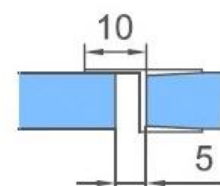

## WS F9

Artikelnummer	für Glasstärke	Länge
WS F9 für 8 mm Glas, L = 2000 mm	6 – 8 mm	2000 mm
WS F9 für 8 mm Glas, L = 2500 mm	6 – 8 mm	2500 mm
WS F9 für 10 mm Glas, L = 2500 mm	10 mm	2500 mm

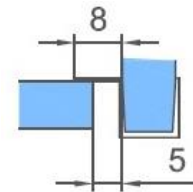

1

## WS F10

Artikelnummer	für Glasstärke	Länge
WS F10 für 8 mm Glas, L = 2000 mm	6 – 8 mm	2000 mm
WS F10 für 8 mm Glas, L = 2500 mm	6 – 8 mm	2500 mm
WS F10 für 10 mm Glas, L = 2500 mm	10 mm	2500 mm

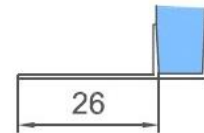

## WS F11

Artikelnummer	für Glasstärke	Länge
WS F11 für 8 mm Glas, L = 2000 mm	6 – 8 mm	2000 mm
WS F11 für 8 mm Glas, L = 2500 mm	6 – 8 mm	2500 mm

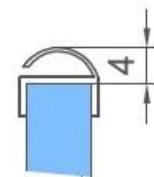

## WS F12

Artikelnummer	für Glasstärke	Länge
WS F12 für 8 mm Glas, L = 2000 mm	6 – 8 mm	2000 mm
WS F12 für 8 mm Glas, L = 2500 mm	6 – 8 mm	2500 mm

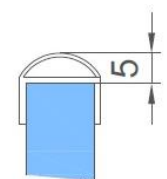

## WS F13

Artikelnummer	für Glasstärke	Länge
WS F13 für 8 mm Glas, L = 2000 mm	6 – 8 mm	2000 mm
WS F13 für 8 mm Glas, L = 2500 mm	6 – 8 mm	2500 mm

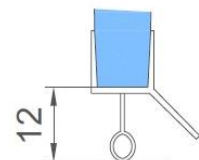

## MS 608-3

Artikelnummer	für Glasstärke	Länge
MS 608-3 für 8 mm Glas, L = 2000 mm	6 – 8 mm	2000 mm
MS 608-3 für 8 mm Glas, L = 2500 mm	6 – 8 mm	2500 mm
MS 608-3 für 10 mm Glas, L = 2500 mm	10 mm	2500 mm

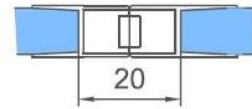

## MS 608-4

Artikelnummer	für Glasstärke	Länge
MS 608-4 für 8 mm Glas, L = 2000 mm	6 – 8 mm	2000 mm
MS 608-4 für 8 mm Glas, L = 2500 mm	6 – 8 mm	2500 mm
MS 608-4 für 10 mm Glas, L = 2500 mm	10 mm	2500 mm

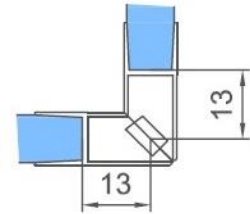

## MS 608-5

Artikelnummer	für Glasstärke	Länge
MS 608-5 für 8 mm Glas, L = 2000 mm	6 – 8 mm	2000 mm
MS 608-5 für 8 mm Glas, L = 2500 mm	6 – 8 mm	2500 mm
MS 608-5 für 10 mm Glas, L = 2500 mm	10 mm	2500 mm

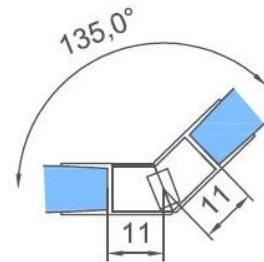

## MS 608-6

Artikelnummer	für Glasstärke	Länge
MS 608-6 für 8 mm Glas, L = 2000 mm	6 – 8 mm	2000 mm
MS 608-6 für 8 mm Glas, L = 2500 mm	6 – 8 mm	2500 mm
MS 608-6 für 10 mm Glas, L = 2500 mm	10 mm	2500 mm

