

INNENTÜREN

2



Magnetschlösser vertikal	64
Magnetschlösser horizontal	69
Schlösser	71
Drücker	80
Hydraulische Bänder	82
Bänder	88
Bandunterteile für FH 400-Serie	92
Selbstschließende Bänder	94
Griffe	95
Versperrbare Griffe	97
Türstopper	100



Magnetschlösser vertikal

Unsere vertikalen Schlösser MVL 012 und MVL 014 sind mit den kurzen Abdeckkappen (links und rechts am Beschlag) und dem Falz ideal für Zargentüren. Zur optischen Aufwertung können die breiteren Abdeckkappen MVL 011-COVER bzw. MVL 013-COVER verwendet werden. Bei beidseitiger Montage der COVERS am Beschlag sind unsere vertikalen Schlösser auch eine Möglichkeit für Pendeltüren. Je nach Bedarf kombinierbar mit dem Gegenkasten MVL 017 oder MVL 018.

Für 8 – 12 mm Glas. 3 verschiedene Oberflächen.

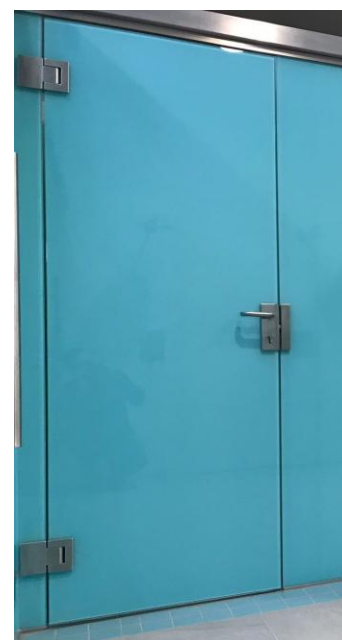
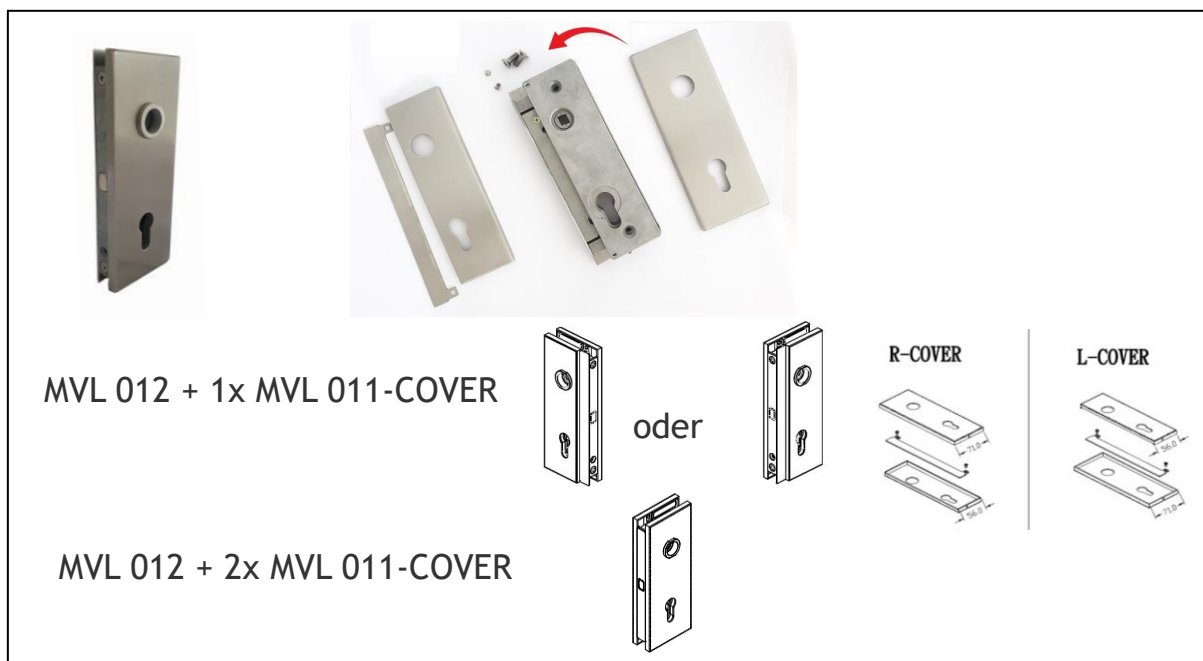
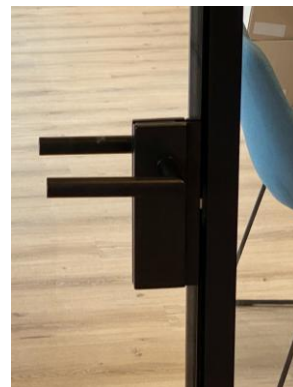

MVL 012

Artikelnummer	Oberfläche
MVL 012.BN	Edelstahl matt
MVL 012.AL	EV1 alu eloxiert
MVL 012.BL	Schwarz matt

BN AL BL

- Magnetschloss vertikal, PZ gerichtet
 - vorgerichtet für Profil-Zylinderlänge 35 – 45 mm
 - für 8 – 12 mm Glas
- Schließblech und Spezifikation auf Seite 64

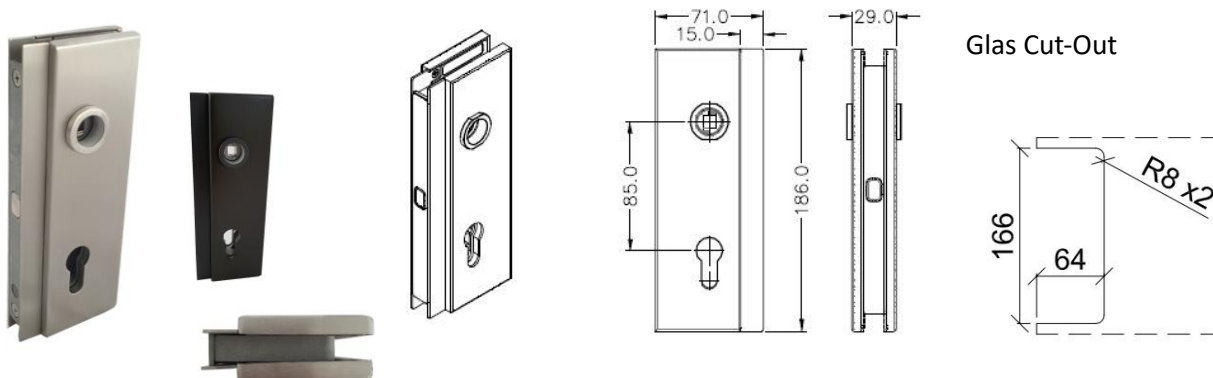

2

MVL 011-COVER

Artikelnummer	Oberfläche
MVL 011-COVER.BN	Edelstahl matt
MVL 011-COVER.AL	EV1 alu eloxiert
MVL 011-COVER.BL	Schwarz matt

BN AL BL

- Abdeckkappe für MVL 012

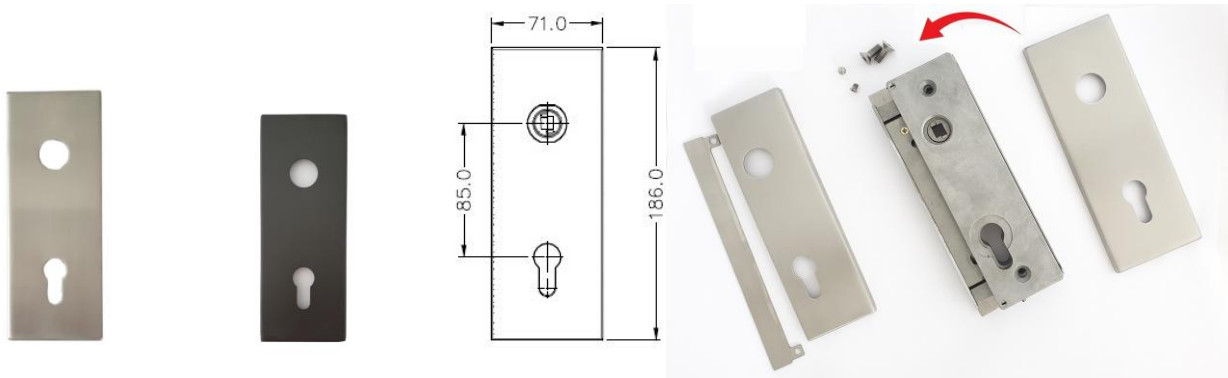

VL 01-BODY

Artikelnummer
VL 01-BODY

- Alternativer Einsatz für MVL 012 oder MVL 014
- für 8 – 12 mm Glas



MVL 014

BN AL BL

Artikelnummer	Oberfläche
MVL 014.BN	Edelstahl matt
MVL 014.AL	EV1 alu eloxiert
MVL 014.BL	Schwarz matt

- Magnetschloss vertikal
- für 8 – 12 mm Glas

Schließblech und Spezifikation auf Seite 64

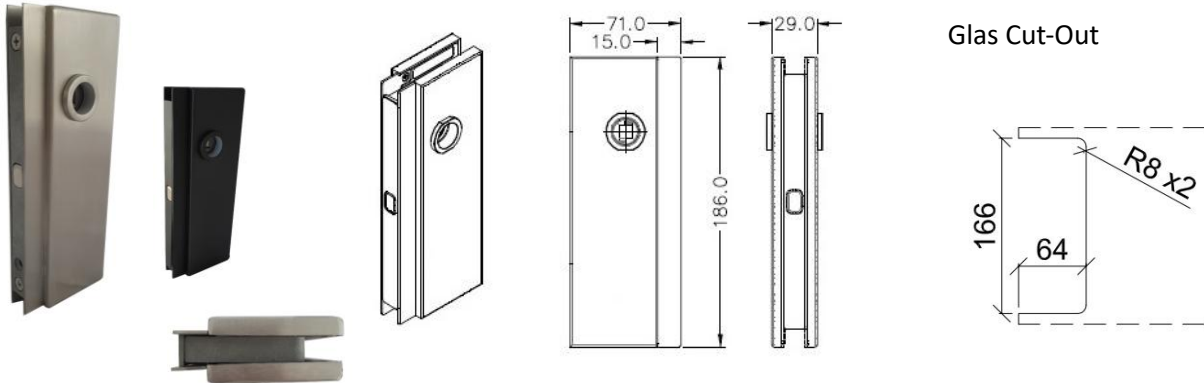

MVL 013-COVER

BN AL BL

Artikelnummer	Oberfläche
MVL 013-COVER.BN	Edelstahl matt
MVL 013-COVER.AL	EV1 alu eloxiert
MVL 013-COVER.BL	Schwarz matt

- Abdeckkappe für MVL 014

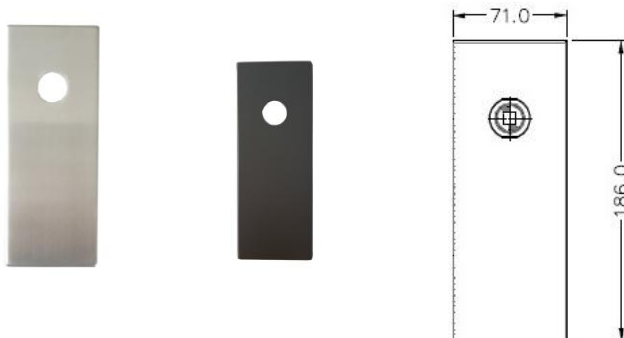

VL 01-BODY

Artikelnummer
VL 01-BODY

- Alternativer Einsatz für MVL 012 oder MVL 014
- für 8 – 12 mm Glas



MVL 017

Artikelnummer	Oberfläche
MVL 017.BN	Edelstahl matt
MVL 017.AL	EV1 alu eloxiert
MVL 017.BL	Schwarz matt

BN AL BL

- Gegenkasten für Magnetschloss vertikal
- für 8 – 12 mm Glas

Spezifikation auf Seite 64

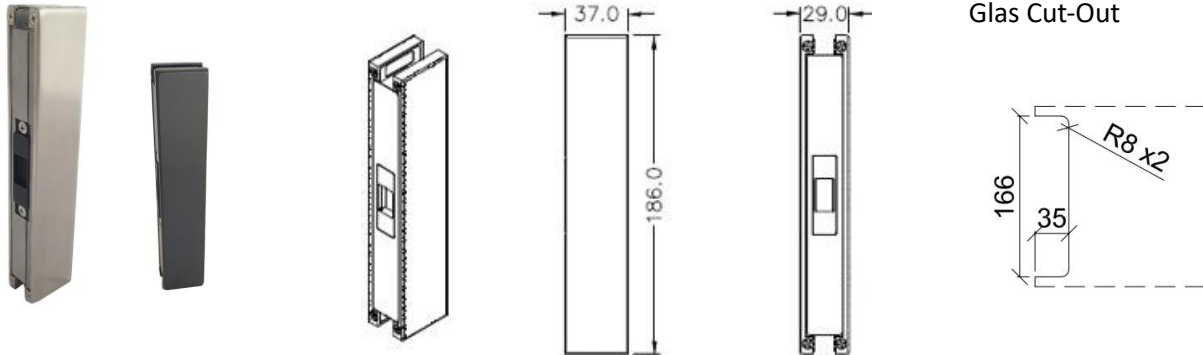

MVL 018

Artikelnummer	Oberfläche
MVL 018.BN	Edelstahl matt
MVL 018.AL	EV1 alu eloxiert
MVL 018.BL	Schwarz matt

BN AL BL

- Gegenkasten für Magnetschloss vertikal,
mit Anschlag

- für 8 – 12 mm Glas

Spezifikation auf Seite 64

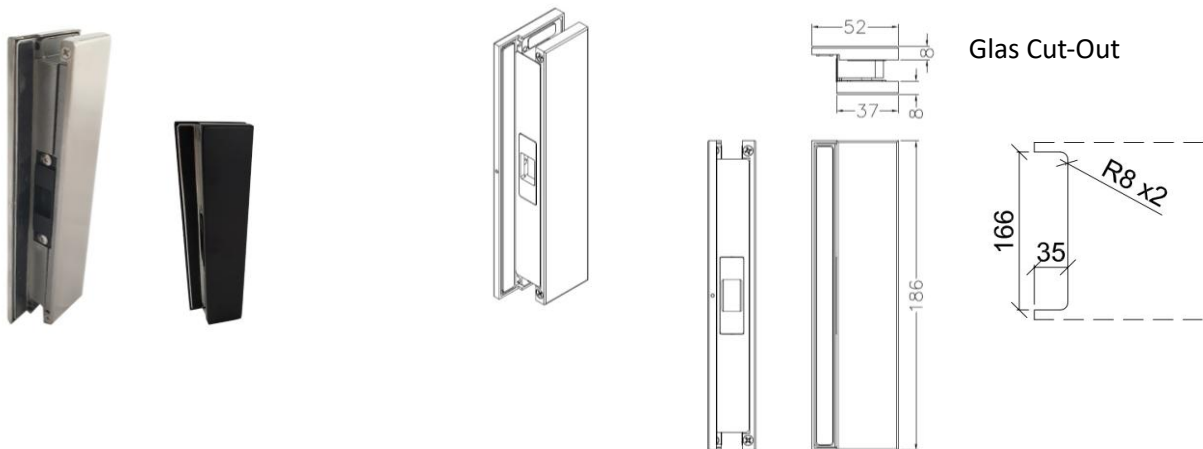

MKP 01

BN BL

Artikelnummer	Oberfläche
MKP 01.BN	Edelstahl matt
MVP 01.BL	Schwarz matt

- Schließblech für Magnetschloss

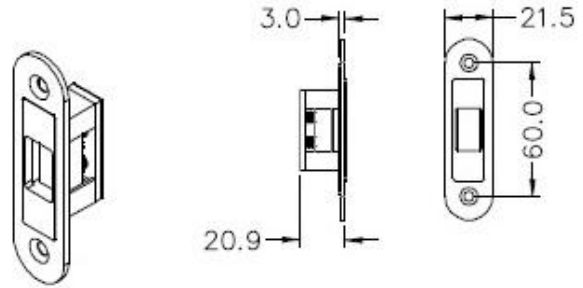

Spezifikation

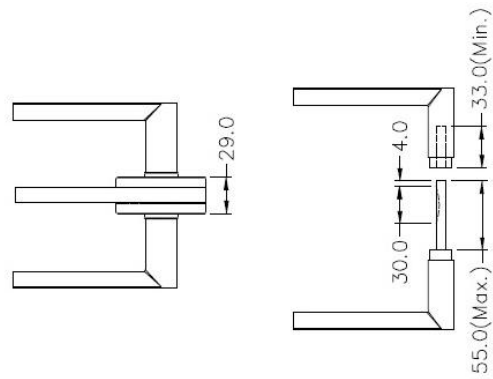
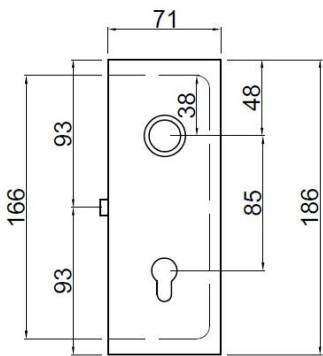

Glasdicke	Dichtung rechte Seite	Dichtung linke Seite
8 mm	1x 3 mm	1x 3 mm
10 mm	1x 2 mm	1x 2 mm
12 mm	1x 1 mm	1x 1 mm

Schließblech für Holzzarge

MVL012

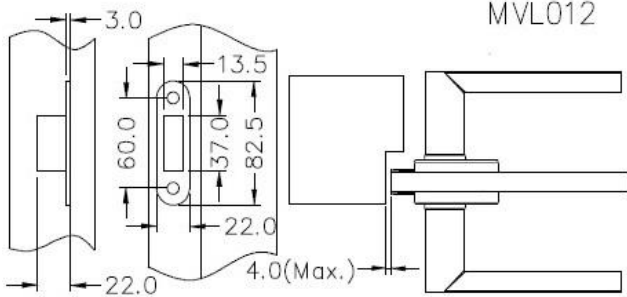

Schließblech für Stahlzarge

MVL012

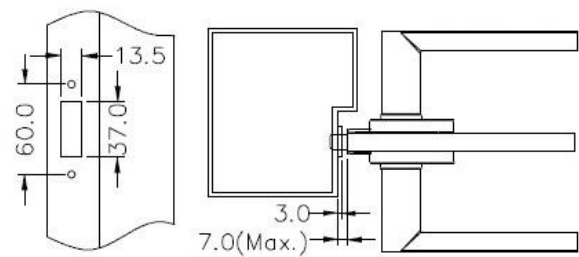

ML 002R

Artikelnummer	Oberfläche
ML 002R.BN	Edelstahl matt
ML 002R.AL	EV1 alu eloxiert
ML 002R.BL	Schwarz matt

BN AL BL

- Magnetschloss horizontal, PZ gerichtet
- vorgerichtet für Profil-Zylinder 31/31 mm oder 31/27 mm
- für 8 – 12 mm Glas

Schließblech und Spezifikation auf Seite 66

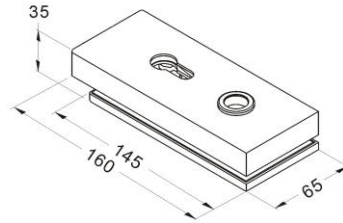

Glas Cut-Out

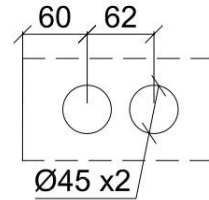

ML 006R

Artikelnummer	Oberfläche
ML 006R.BN	Edelstahl matt
ML 006R.AL	EV1 alu eloxiert
ML 006R.BL	Schwarz matt

BN AL BL

- Magnetschloss horizontal, Drücker vorne
- für 8 – 12 mm Glas

Schließblech und Spezifikation auf Seite 66

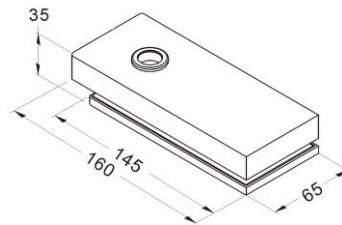

Glas Cut-Out

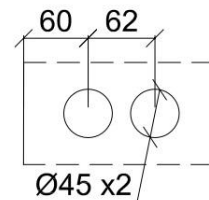

ML 018R

Artikelnummer	Oberfläche
ML 018R.BN	Edelstahl matt
ML 018R.AL	EV1 alu eloxiert
ML 018R.BL	Schwarz matt

BN AL BL

- Gegenkasten für Magnetschloss horizontal
- für 8 – 12 mm Glas

Spezifikation auf Seite 66

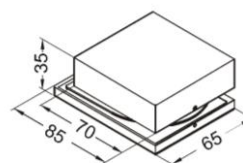

Glas Cut-Out

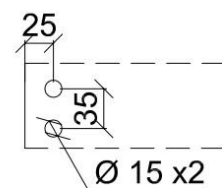

MKP 01

Artikelnummer	Oberfläche
MKP 01.BN	Edelstahl matt
MVP 01.BL	Schwarz matt

BN **BL**

- Schließblech für Magnetschloss

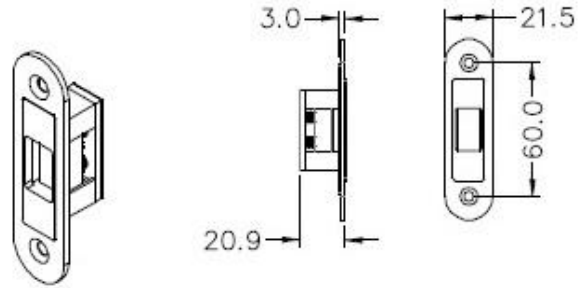

Spezifikation

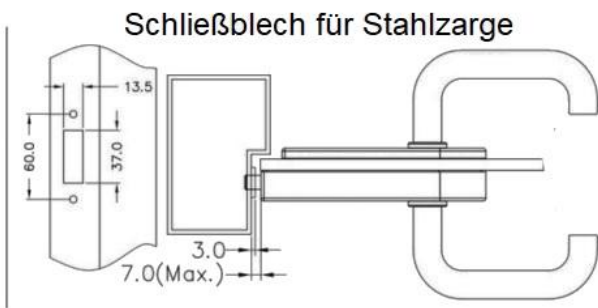
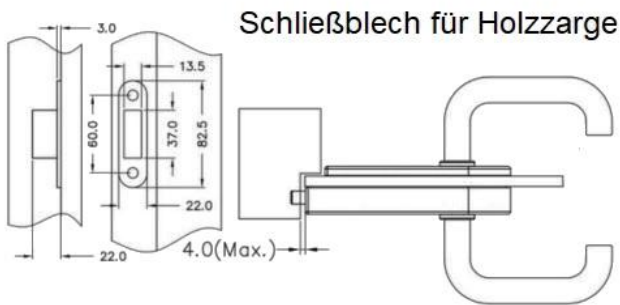

PL 002G

BN AL

Artikelnummer	Oberfläche
PL 002G.BN	Edelstahl matt
PL 002G.AL	EV1 alu eloxiert

- Schlosskasten, PZ gerichtet
- für 8 – 10 mm Glas
- vorgefertigt für Profil-Zylinder 31/31 mm oder 27/31

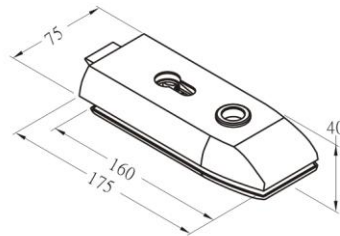

Glas Cut-Out

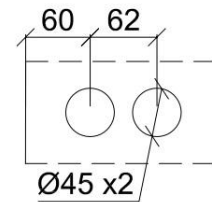

PL 004G

BN AL

Artikelnummer	Oberfläche
PL 004G.BN	Edelstahl matt
PL 004G.AL	EV1 alu eloxiert

- Schlosskasten, Drücker hinten
- für 8 – 10 mm Glas

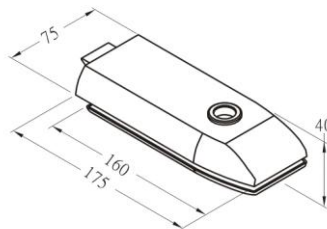

Glas Cut-Out

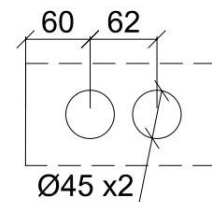

PL 006G

BN AL

Artikelnummer	Oberfläche
PL 006G.BN	Edelstahl matt
PL 006G.AL	EV1 alu eloxiert

- Schlosskasten, Drücker vorne
- für 8 – 10 mm Glas

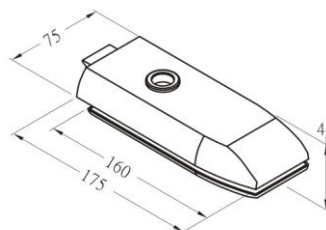

Glas Cut-Out

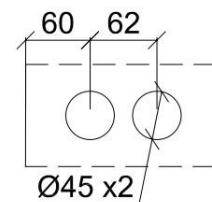

2



WLI 002G

BN

Artikelnummer	Oberfläche
WLI 002G.BN Outward	Edelstahl matt
WLI 002G.BN Inward	Edelstahl matt

- Schlosskasten mit WC-Riegelolive
- für 8 – 10 mm Glas

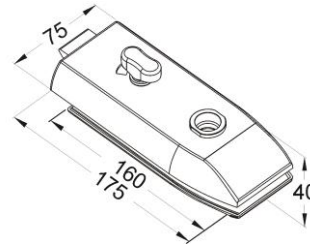

Glas Cut-Out

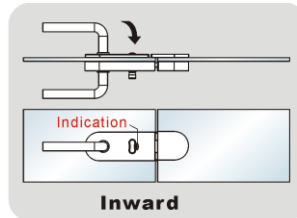
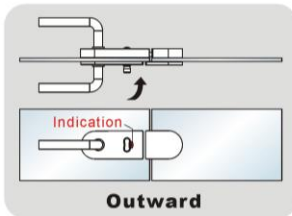
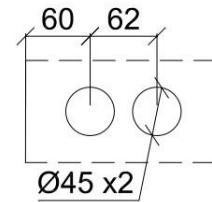

PL 008G

BN

AL

Artikelnummer	Oberfläche
PL 008G.BN	Edelstahl matt
PL 008G.AL	EV1 alu eloxiert

- Gegenkasten
- für 8 – 10 mm Glas

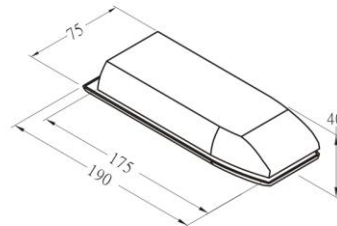

Glas Cut-Out

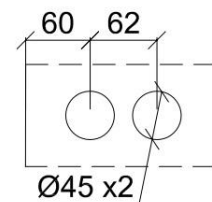

PL 018G

BN

AL

Artikelnummer	Oberfläche
PL 018G.BN	Edelstahl matt
PL 018G.AL	EV1 alu eloxiert

- Gegenkasten klein
- für 8 – 10 mm Glas

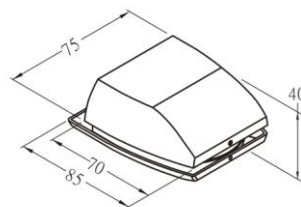

Glas Cut-Out

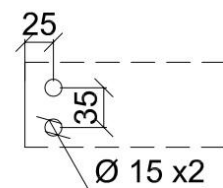

PL 012G

Artikelnummer	Oberfläche
PL 012G.BN	Edelstahl matt

BN

- Schlosskasten klein, PZ gerichtet
 - für 8 – 10 mm Glas
 - vorbereitet für Profil-Zylinder 31/31 mm oder 31/27 mm
- Falle bzw. Flüster-Falle für ÖNORM-Zarge passt nicht bei PL 012G, PL 014G und PL 016G

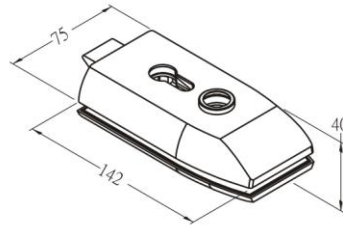

Glas Cut-Out

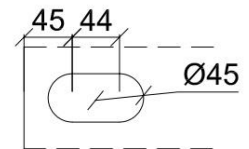

PL 014G

Artikelnummer	Oberfläche
PL 014G.BN	Edelstahl matt

BN

- Schlosskasten klein, Drücker hinten
 - für 8 – 10 mm Glas
- Falle bzw. Flüster-Falle für ÖNORM-Zarge passt nicht bei PL 012G, PL 014G und PL 016G

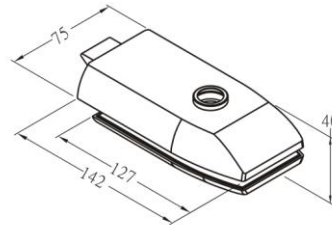

Glas Cut-Out

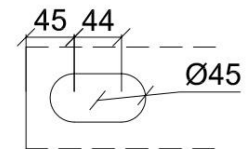

PL 016G

Artikelnummer	Oberfläche
PL 016G.BN	Edelstahl matt

BN

- Schlosskasten klein, Drücker vorne
 - für 8 – 10 mm Glas
- Falle bzw. Flüster-Falle für ÖNORM-Zarge passt nicht bei PL 012G, PL 014G und PL 016G

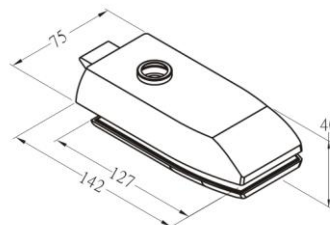

Glas Cut-Out

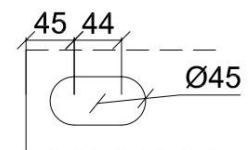

2

PL 002S

Artikelnummer	Oberfläche
PL 002S.BN	Edelstahl matt
PL 002S.AL	EV1 alu eloxiert

BN AL

- Schlosskasten, PZ vorbereitet
- vorbereitet für Profil-Zylinder 31/31 mm oder 31/27 mm
- für 8 – 10 mm Glas

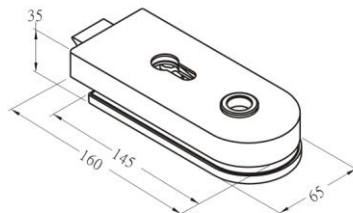

Glas Cut-Out

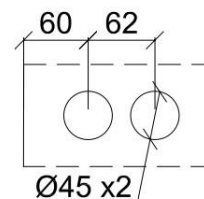

PL 004S

Artikelnummer	Oberfläche
PL 004S.BN	Edelstahl matt
PL 004S.AL	EV1 alu eloxiert

BN AL

- Schlosskasten, Drücker hinten
- für 8 – 10 mm Glas

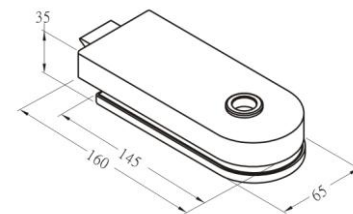

Glas Cut-Out

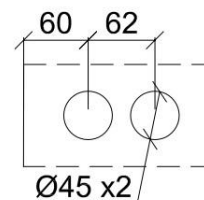

PL 006S

Artikelnummer	Oberfläche
PL 006S.BN	Edelstahl matt
PL 006S.AL	EV1 alu eloxiert

BN AL

- Schlosskasten, Drücker vorne
- für 8 – 10 mm Glas

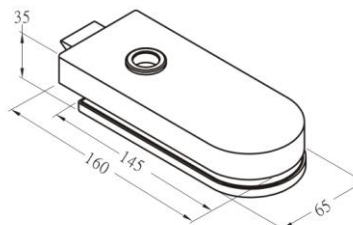

Glas Cut-Out

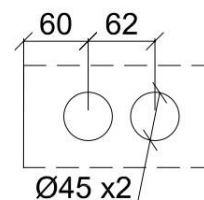

PL 008S

BN AL

Artikelnummer	Oberfläche
PL 008S.BN	Edelstahl matt
PL 008S.AL	EV1 alu eloxiert

- Gegenkasten
- für 8 – 10 mm Glas

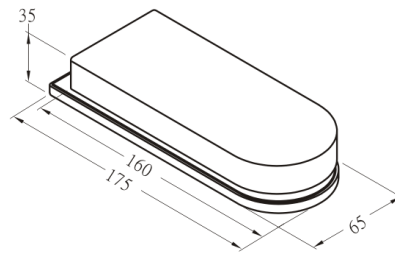

Glas Cut-Out

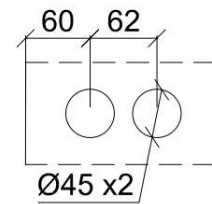

PL 018S

BN AL

Artikelnummer	Oberfläche
PL 018S.BN	Edelstahl matt
PL 018S.AL	EV1 alu eloxiert

- Gegenkasten klein
- für 8 – 10 mm Glas

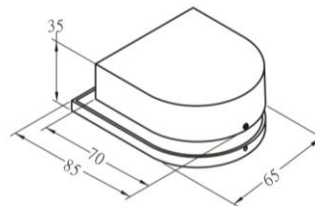

Glas Cut-Out

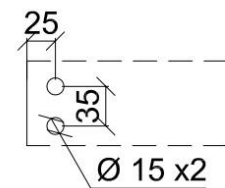

2

PL 002R

BN AL BL

Artikelnummer	Oberfläche
PL 002R.BN	Edelstahl matt
PL 002R.AL	EV1 alu eloxiert
PL 002R.BL	Schwarz matt

- Schlosskasten, PZ vorgerichtet
- vorgerichtet für Profil-Zylinder 31/31 mm oder 31/27 mm
- für 8 – 10 mm Glas

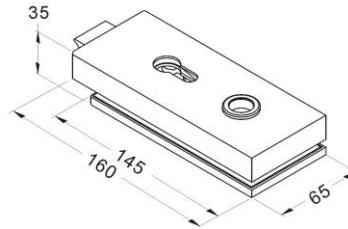
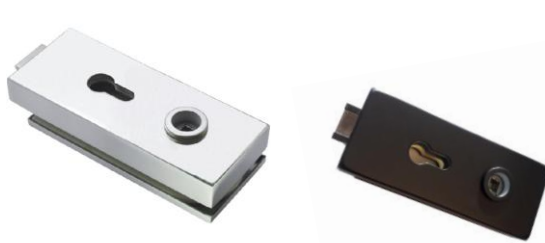

Glas Cut-Out

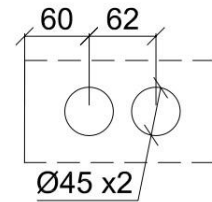

PL 002R-BBKEY

BN AL

Artikelnummer	Oberfläche
PL 002R-BBKEY.BN	Edelstahl matt
PL 002R-BBKEY.AL	EV1 alu eloxiert

- Schlosskasten, BB vorgerichtet
- für 8 – 10 mm Glas

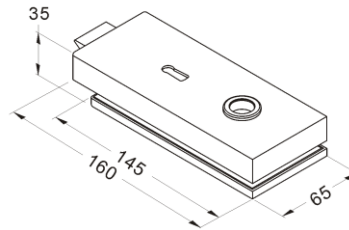

Glas Cut-Out

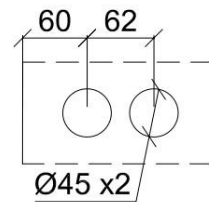

PL 004R

BN AL

Artikelnummer	Oberfläche
PL 004R.BN	Edelstahl matt
PL 004R.AL	EV1 alu eloxiert

- Schlosskasten, Drücker hinten
- für 8 – 10 mm Glas

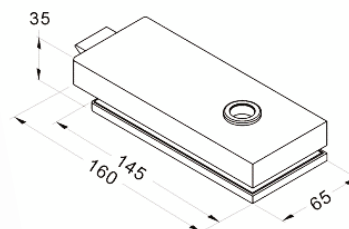
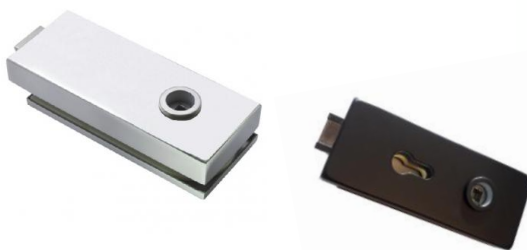

Glas Cut-Out

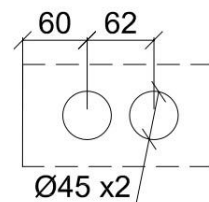

PL 006R

BN AL BL

Artikelnummer	Oberfläche
PL 006R.BN	Edelstahl matt
PL 006R.AL	EV1 alu eloxiert
PL 006R.BL	Schwarz matt

- Schlosskasten, Drücker vorne
- für 8 – 10 mm Glas

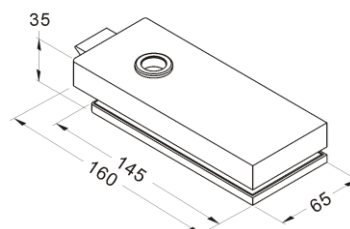

Glas Cut-Out

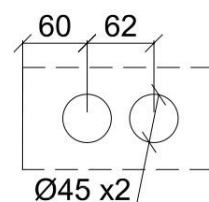

WLI 002R

BN AL

Artikelnummer	Oberfläche
WLI 002R.BN Outward	Edelstahl matt
WLI 002R.BN Inward	Edelstahl matt
WLI 002R.AL Outward	EV1 alu eloxiert
WLI 002R.AL Inward	EV1 alu eloxiert

- Schlosskasten mit WC-Riegelolive
- für 8 – 10 mm Glas

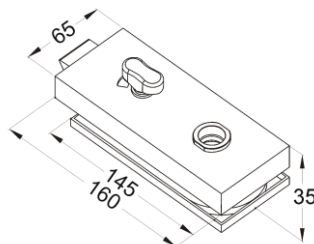

Glas Cut-Out

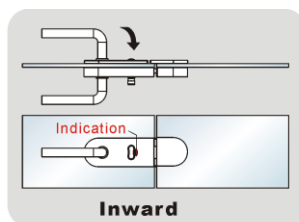
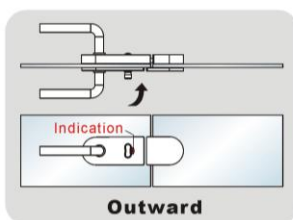
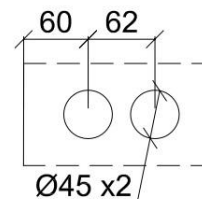

2

PL 008R

BN AL

Artikelnummer	Oberfläche
PL 008R.BN	Edelstahl matt
PL 008R.AL	EV1 alu eloxiert

- Gegenkasten
- für 8 - 10 mm Glas

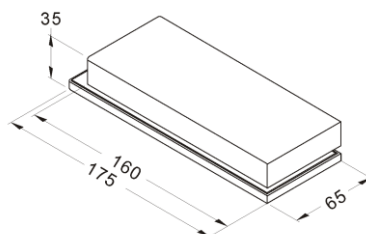

Glas Cut-Out

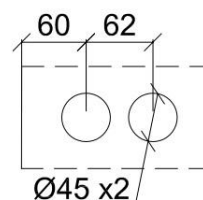

PL 018R

BN AL BL

Artikelnummer	Oberfläche
PL 018R.BN	Edelstahl matt
PL 018R.AL	EV1 alu eloxiert
PL 018R.BL	Schwarz matt

- Gegenkasten klein
- für 8 – 10 mm Glas

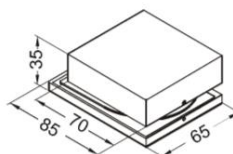

Glas Cut-Out

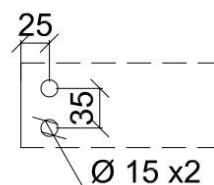

WC 03-B

Artikelnummer	Oberfläche
WC 03-B.BN	Edelstahl matt
WC 03-B.AL	EV1 alu eloxiert
WC 03-B.BL	Schwarz matt

BN AL BL

- WC-Zylinder mit Knauf, verschiedenschließend
Sicherungsstift bei Knauf mit Durchschlag durchdrücken

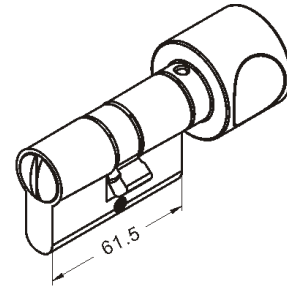
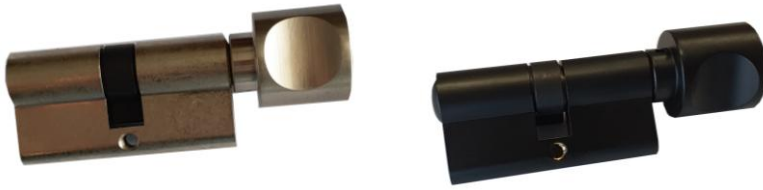

DC 02

Artikelnummer	Oberfläche
DC 02.BN	Edelstahl matt
DC 02.AL	EV1 alu eloxiert

- Profilzylinder, verschiedenschließend, inkl. 3 Schlüssel

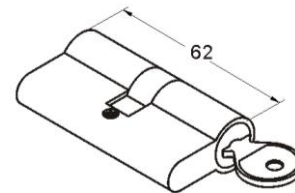

TC 02

Artikelnummer	Oberfläche
TC 02.BN	Edelstahl matt
TC 02.AL	EV1 alu eloxiert

BN AL

- Profilzylinder mit Knauf, verschiedenschließend, inkl. 3 Schlüssel

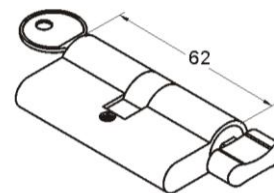

KP 02

Artikelnummer	Oberfläche
KP 02.AL	EV1 alu eloxiert

AL

- Schließblech

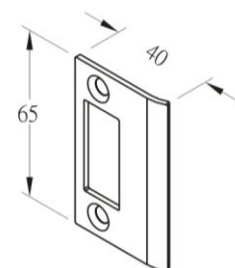

KP 03

Artikelnummer	Oberfläche
KP 03.AL	EV1 alu eloxiert

AL

- Schließblech

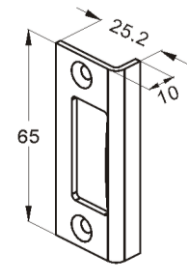

PL 07C

Artikelnummer	Oberfläche
PL 07C.BN	Edelstahl matt

BN

- Schließblech

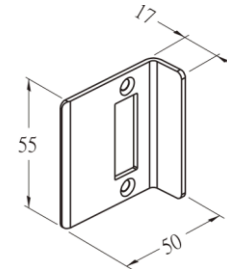

Flüster-Falle für ÖNORM-Zarge

Artikelnummer
Flüster-Falle für ÖNORM-Zarge



BC 028

Artikelnummer	Oberfläche
BC 028.BN	Edelstahl matt

BN

- Kugelschnäpper



LB 049

Artikelnummer	Oberfläche	Glasstärke
LB 049-8.BN	Edelstahl matt	für 8 mm Glas
LB 049-10.BN	Edelstahl matt	für 10 mm Glas

BN

- Feststeller inkl. Bodenbuchse

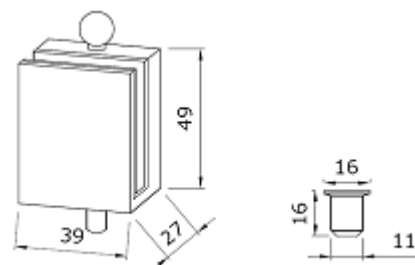

LH 102

Artikelnummer	Oberfläche
LH 102.BN	Edelstahl matt
LH 102.AL	EV1 alu eloxiert
LH 102.BL	Schwarz matt

BN AL BL



LH 103

Artikelnummer	Oberfläche
LH 103.BN	Edelstahl matt

BN



LH 105

Artikelnummer	Oberfläche
LH 105.BN	Edelstahl matt
LH 105.AL	EV1 alu eloxiert

BN AL



LH 107

Artikelnummer	Oberfläche
LH 107.BN	Edelstahl matt

BN



LH 111

Artikelnummer	Oberfläche
LH 111.BN	Edelstahl matt
LH 111.AL	EV1 alu eloxiert

BN AL



LH 112

Artikelnummer	Oberfläche
LH 112.BN	Edelstahl matt
LH 112.AL	EV1 alu eloxiert

BN

AL



LH 201

Artikelnummer	Oberfläche
LH 201.BN	Edelstahl matt
LH 201.BL	Schwarz matt

BN

BL



2

Hurrikan EVO2 – Hydraulische Bänder

Sind die nächste Generation unserer Hurrikan-Bänder. Unsere neuen hydraulischen einstellbaren Bänder haben einen verbesserten Mechanismus. Durch die eckige Form und die verdeckten Schrauben finden Sie ein modernes Design für viele Anwendungsmöglichkeiten. Einstellbare Nulllage. Einstellbare Schließgeschwindigkeit.

für 8 – 12 mm Glasstärke. 5 verschiedene Oberflächen.



Türstopper auf Boden erforderlich
Türanschlag bei 90°

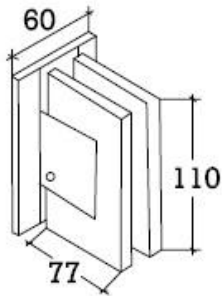

HHC 101

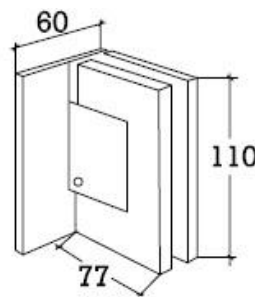

HHC 100

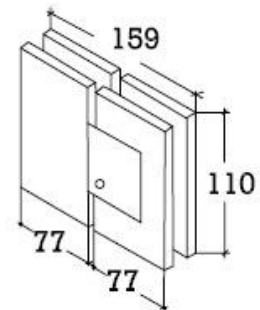

HH 103

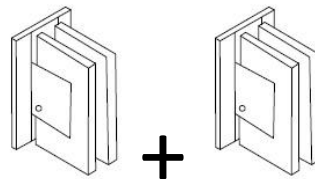
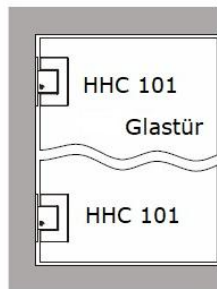

Max. Türgewicht: 100 kg
Max. Türbreite: 1000 mm
Max. Türhöhe: 2800 mm

Bei Kombination von **zwei Bändern MIT Hydraulikfunktion**

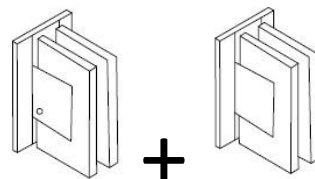
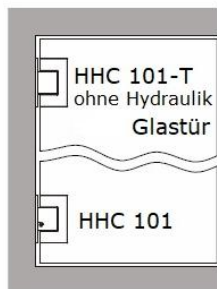

Max. Türgewicht: 55 kg
Max. Türbreite: 900 mm
Max. Türhöhe: 2400 mm

Bei Kombination von **einem Band MIT Hydraulikfunktion und einem Band OHNE Hydraulikfunktion**

HHC 101 *Hurrikan EVO2

V2A V4A AL BL GO

Artikelnummer	Oberfläche
HHC 101.V2A	V2A Edelstahl matt
HHC 101.V4A	V4A Edelstahl matt
HHC 101.AL	EV1 alu eloxiert
HHC 101.BL	Schwarz matt RAL 9005
HHC 101.GO	Messing poliert

- Pendeltürband mit einstellbarer Nulllage
- MIT Hydraulikfunktion
- mit Abdeckkappen
- Glas/Wand, 90°, beidseitig
- für 8 – 12 mm Glas

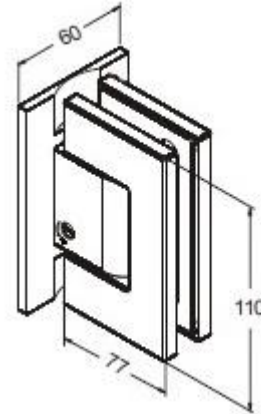

Glas Cut-Out

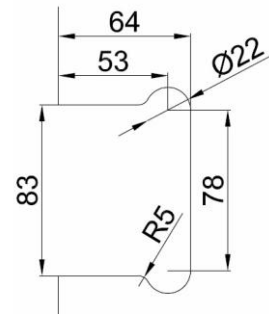

Anschraubplatte:

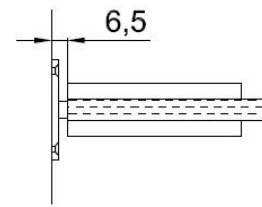
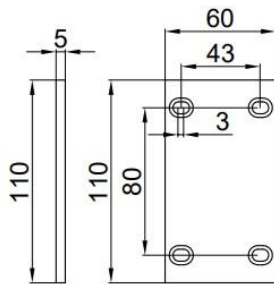

HHC 101-T *Hurrikan EVO2

V2A V4A AL BL

Artikelnummer	Oberfläche
HHC 101-TV2A	V2A Edelstahl matt
HHC 101-TV4A	V4A Edelstahl matt
HHC 101-T.AL	EV1 alu eloxiert
HHC 101-T.BL	Schwarz matt RAL 9005

- Pendeltürband, freidrehendes Band
- OHNE Hydraulikfunktion
- mit Abdeckkappen
- Glas/Wand, 90°, beidseitig
- für 8 – 12 mm Glas

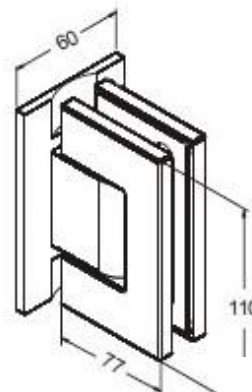

Glas Cut-Out

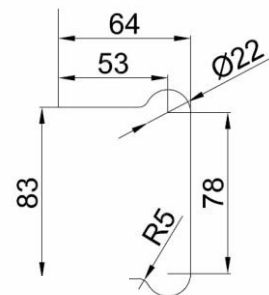

Anschraubplatte:

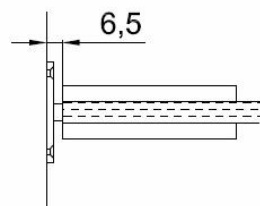
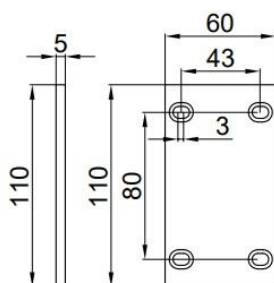

HHC 100 *Hurrikan EVO2

V2A V4A AL BL

Artikelnummer	Oberfläche
HHC 100.V2A	V2A Edelstahl matt
HHC 100.V4A	V4A Edelstahl matt
HHC 100.AL	EV1 alu eloxiert
HHC 100.BL	Schwarz matt RAL 9005

- Pendeltürband mit einstellbarer Nulllage
- MIT Hydraulikfunktion
- mit Abdeckkappen
- Glas/Wand, 90°, einseitig
- für 8 – 12 mm Glas

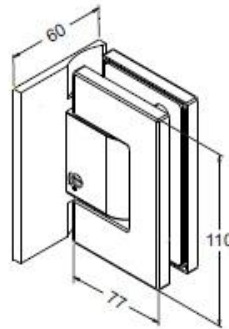

Glas Cut-Out

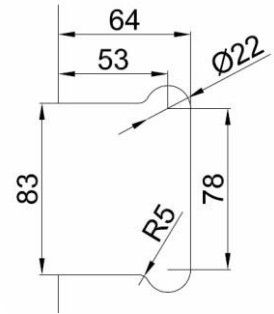

Anschraubplatte:

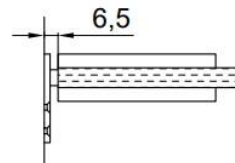
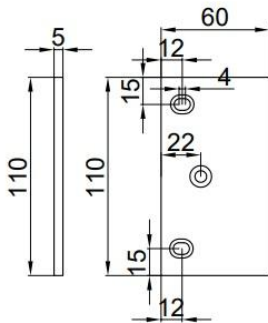

HHC 100-T *Hurrikan EVO2

V2A V4A AL BL

Artikelnummer	Oberfläche
HHC 100-T.V2A	V2A Edelstahl matt
HHC 100-T.V4A	V4A Edelstahl matt
HHC 100-T.AL	EV1 alu eloxiert
HHC 100-T.BL	Schwarz matt RAL 9005

- Pendeltürband, freidrehendes Band
- OHNE Hydraulikfunktion
- mit Abdeckkappen
- Glas/Wand, 90°, einseitig
- für 8 – 12 mm Glas

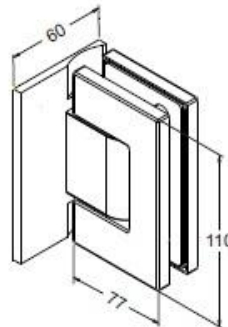

Glas Cut-Out

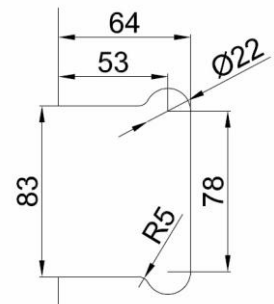

Anschraubplatte:

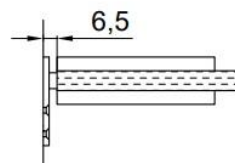
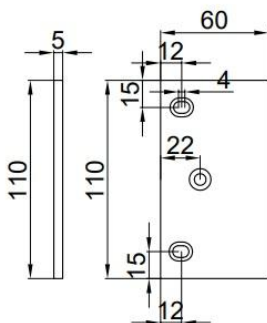

HHC 100_PLATE

V4A AL BL

Artikelnummer	Oberfläche
HHC 100_PLATE.V4A	V4A Edelstahl matt
HHC 100_PLATE.AL	EV1 alu eloxiert
HHC 100_PLATE.BL	Schwarz matt RAL 9005

- Gegenplatte für HHC 100 bzw. HHC 100-T
- für Glas/Glas, 90°
- für 8 – 12 mm Glas



2

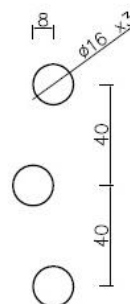
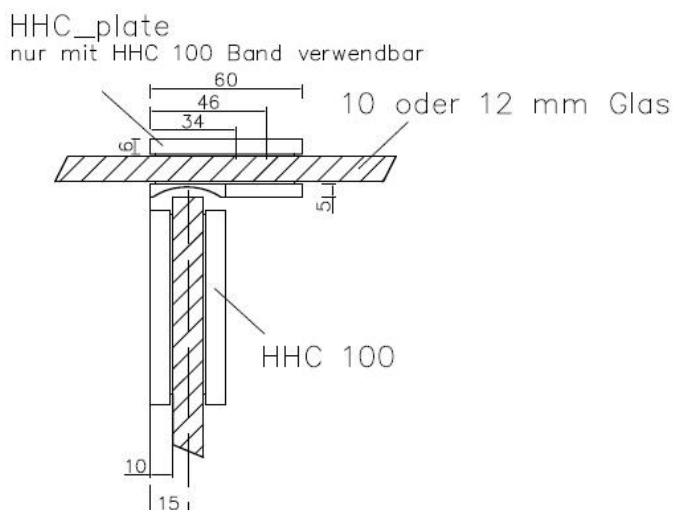
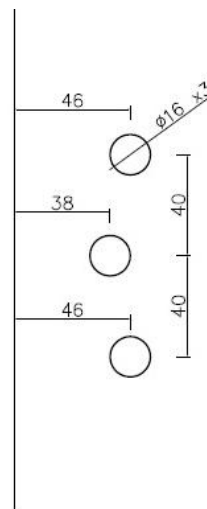
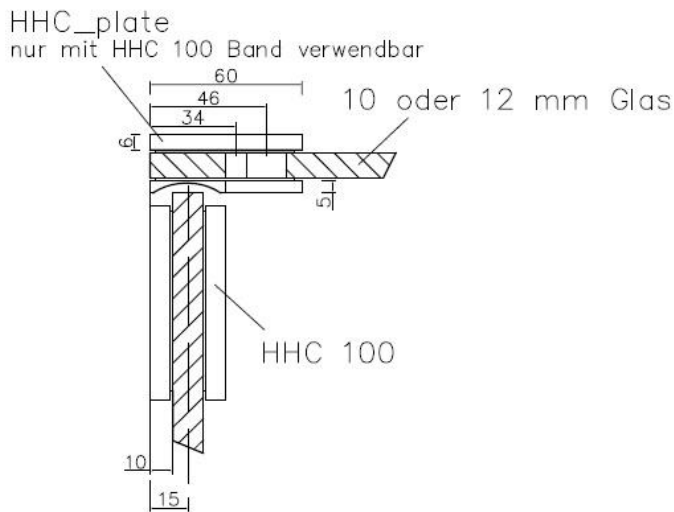

HH 101

V2A AL BL

Artikelnummer	Oberfläche
HH 101.V2A	V2A Edelstahl matt
HH 101.AL	EV1 alu eloxiert
HH 101.BL	Schwarz matt RAL 9005

- Pendeltürband mit einstellbarer Nulllage
- MIT Hydraulikfunktion
- ohne Abdeckkappen
- Glas/Wand, 90°, beidseitig
- für 8 – 12 mm Glas

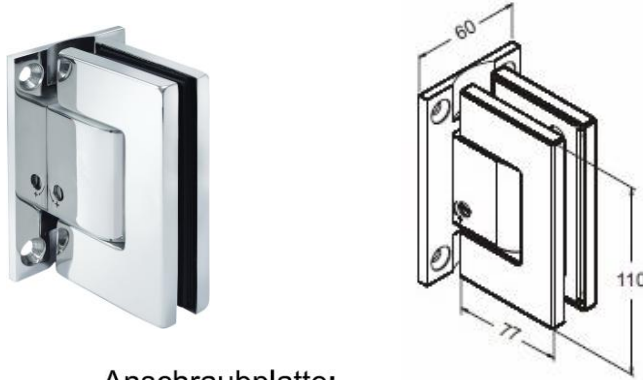

Glas Cut-Out

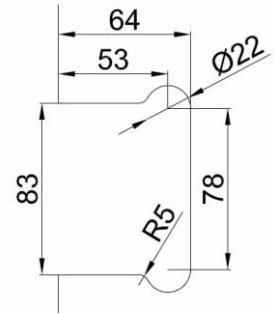

Anschraubplatte:

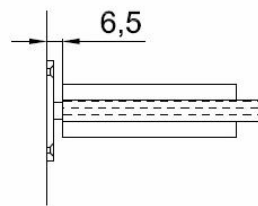
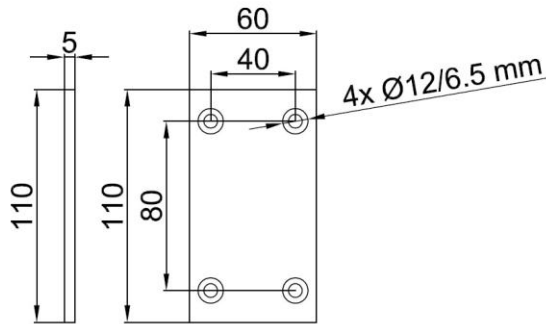

HH 101-T

V2A AL

Artikelnummer	Oberfläche
HH 101-T.V2A	V2A Edelstahl matt
HH 101-T.AL	EV1 alu eloxiert

- Pendeltürband, freidrehendes Band
- OHNE Hydraulikfunktion
- ohne Abdeckkappen
- Glas/Wand, 90°, beidseitig
- für 8 – 12 mm Glas

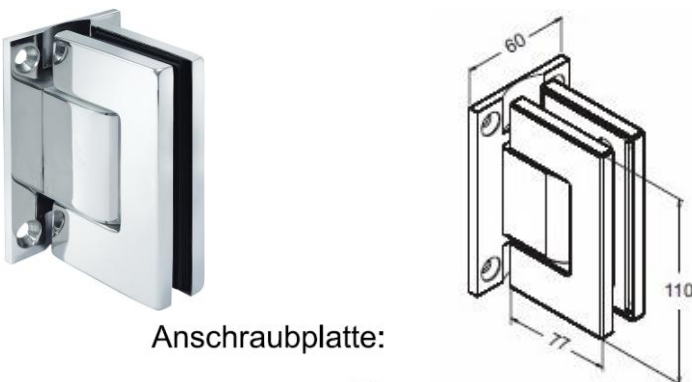

Glas Cut-Out

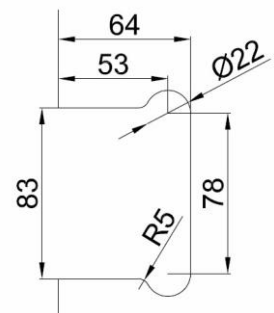

Anschraubplatte:

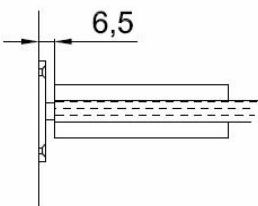
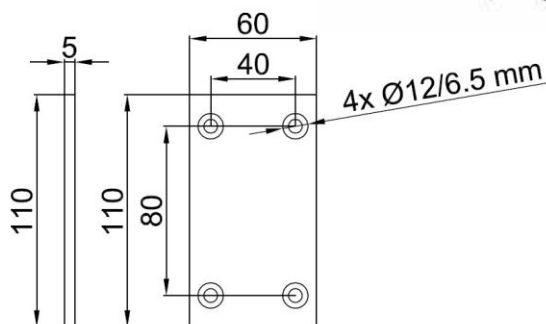

HH 103 *Hurrikan EVO2

V2A V4A AL BL GO

Artikelnummer	Oberfläche
HH 103.V2A	V2A Edelstahl matt
HH 103.V4A	V4A Edelstahl matt
HH 103.AL	EV1 alu eloxiert
HH 103.BL	Schwarz matt RAL 9005
HH 103.GO	Messing poliert

- Pendeltürband mit einstellbarer Nulllage
- MIT Hydraulikfunktion
- Glas/Glas, 180°
- für 8 – 12 mm Glas

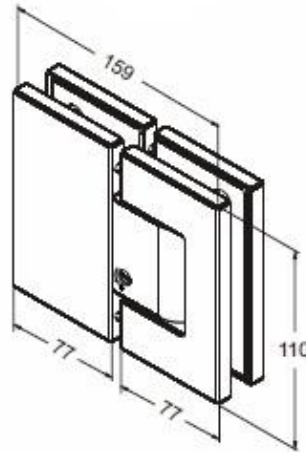

Glas Cut-Out

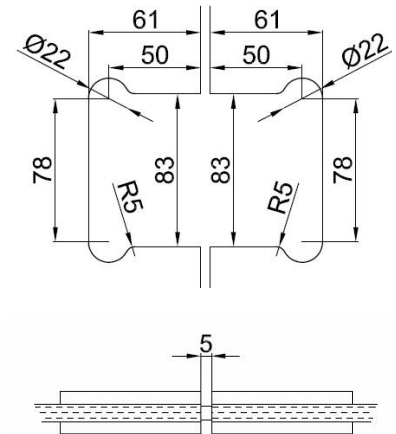

2

HH 103-T *Hurrikan EVO2

V2A V4A AL BL

Artikelnummer	Oberfläche
HH 103-T.V2A	V2A Edelstahl matt
HH 103-T.V4A	V4A Edelstahl matt
HH 103-T.AL	EV1 alu eloxiert
HH 103-T.BL	Schwarz matt RAL 9005

- Pendeltürband, freidrehendes Band
- OHNE Hydraulikfunktion
- Glas/Glas, 180°
- für 8 – 12 mm Glas

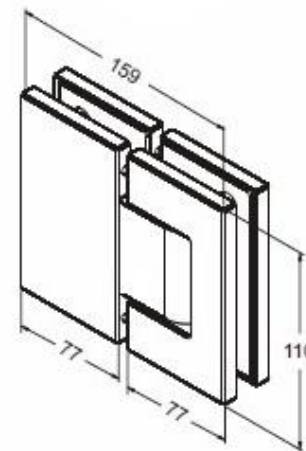

Glas Cut-Out

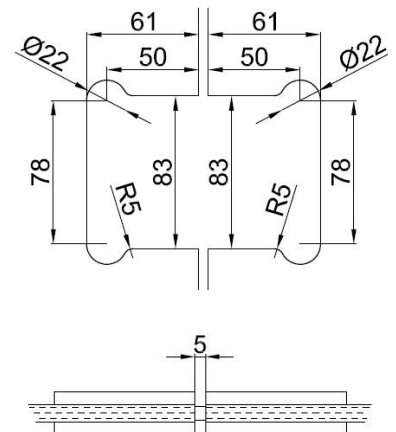

FH 400G

Artikelnummer	Oberfläche
FH 400G.BN	Edelstahl matt
FH 400G.AL	EV1 alu eloxiert

BN AL

- für 8 – 10 mm Glas



Max. Türgewicht: 45 kg/ 2 Bänder
Max. Türbreite: 1000 mm/ 2 Bänder

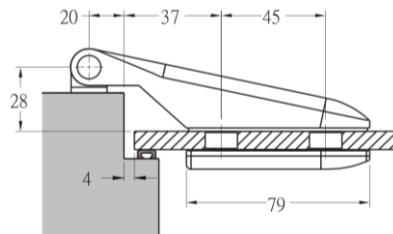
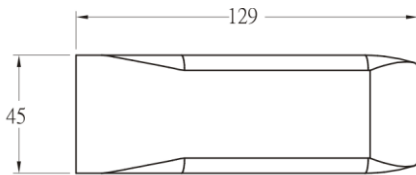

Glas Cut-Out

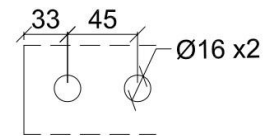

FH 400N

Artikelnummer	Oberfläche
FH 400N.BN	Edelstahl matt
FH 400N.AL	EV1 alu eloxiert

BN AL

- für 8 – 10 mm Glas



Max. Türgewicht: 45 kg/ 2 Bänder
Max. Türbreite: 1000 mm/ 2 Bänder

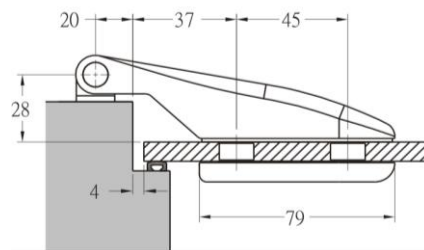
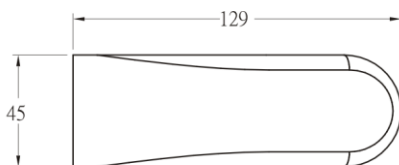

Glas Cut-Out

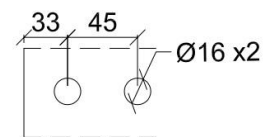

FH 400R

Artikelnummer	Oberfläche
FH 400R.BN	Edelstahl matt
FH 400R.AL	EV1 alu eloxiert

BN AL

- für 8 – 10 mm Glas



Max. Türgewicht: 45 kg/ 2 Bänder
Max. Türbreite 1000 mm/ 2 Bänder

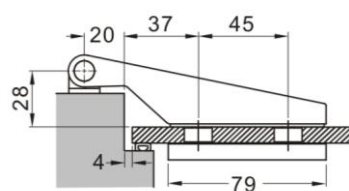

Glas Cut-Out

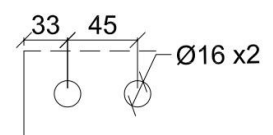

FH 410C

Artikelnummer	Oberfläche
FH 410C.BN	Edelstahl matt
FH 410C.AL	EV1 alu eloxiert

BN AL

- für 8 – 10 mm Glas



Max. Türgewicht: 55 kg/ 2 Bänder
Max. Türbreite: 1000 mm/ 2 Bänder

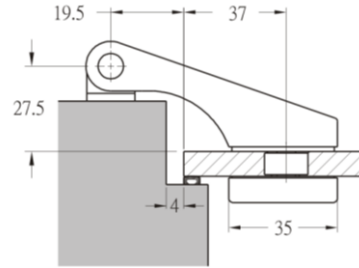
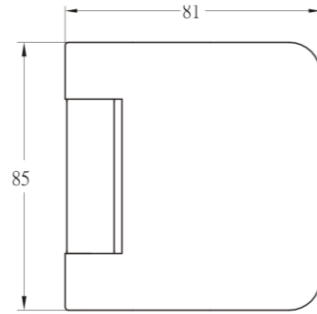

Glas Cut-Out

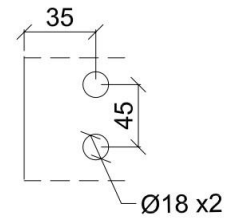

FH 410G

Artikelnummer	Oberfläche
FH 410G.BN	Edelstahl matt
FH 410G.AL	EV1 alu eloxiert

BN AL

- für 8 – 10 mm Glas



Max. Türgewicht: 55 kg/ 2 Bänder
Max. Türbreite: 1000 mm/ 2 Bänder

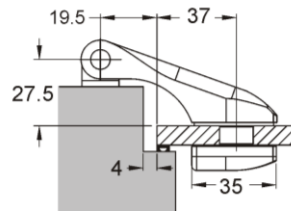
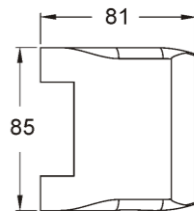

Glas Cut-Out

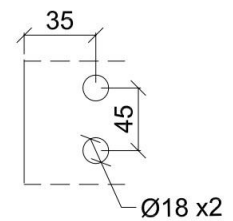

FH 410S

Artikelnummer	Oberfläche
FH 410S.BN	Edelstahl matt
FH 410S.AL	EV1 alu eloxiert
FH 410S.BL	Schwarz matt

BN AL BL

- für 8 – 10 mm Glas



Max. Türgewicht: 55 kg/ 2 Bänder
Max. Türbreite: 1000 mm/ 2 Bänder

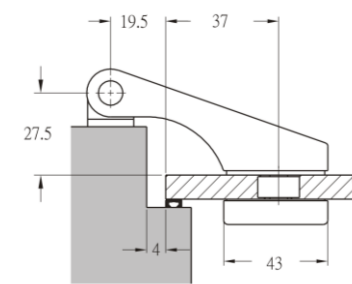
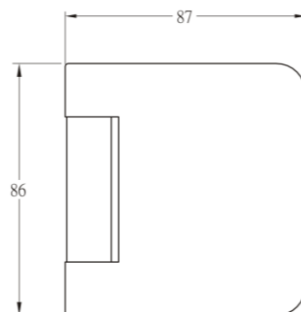

Glas Cut-Out

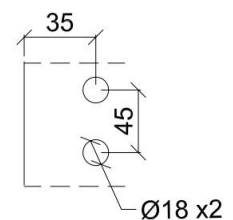

2

FH 411C

Artikelnummer	Oberfläche
FH 411C.BN	Edelstahl matt
FH 411C.AL	EV1 alu eloxiert

BN AL

- für 8 – 10 mm Glas



Max. Türgewicht: 55 kg/ 2 Bänder
Max. Türbreite: 1000 mm/ 2 Bänder

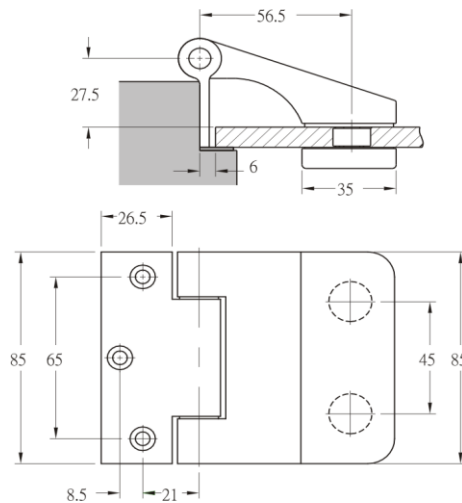

Glas Cut-Out

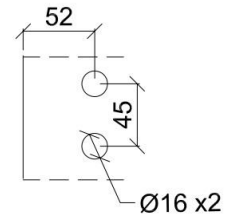

FH 416R

Artikelnummer	Oberfläche
FH 416R.BN	Edelstahl matt
FH 416R.PC	Chrom glänzend

BN PC

- Türband, Glas/Glas, 180°

- für 8 – 10 mm Glas



Max. Türgewicht: 40 kg/ 2 Bänder
Max. Türbreite: 700 mm/ 2 Bänder

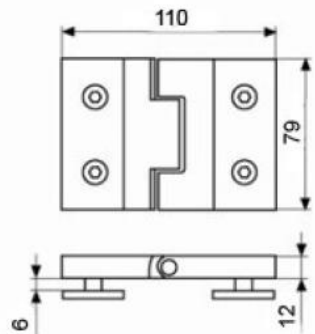

Glas Cut-Out

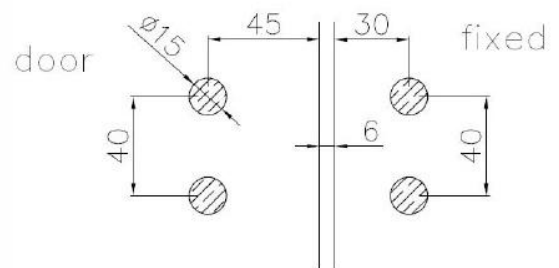

FH 061R

Artikelnummer	Oberfläche
FH 061R.BN	Edelstahl matt
FH 061R.AL	EV1 alu eloxiert
FH 061R.BL	Schwarz matt

BN AL BL

- Zargenunabhängiges Band
- für 8 – 10 mm Glas



Max. Türgewicht: 40 kg/ 2 Bänder
Max. Türbreite: 1000 mm/ 2 Bänder

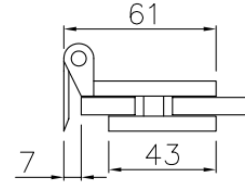
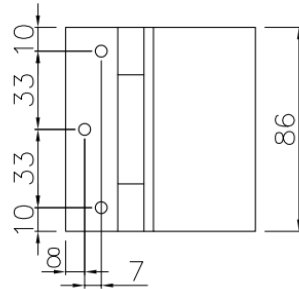

Glas Cut-Out

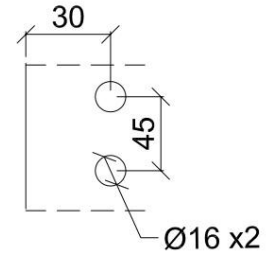

FH 061S

Artikelnummer	Oberfläche
FH 061S.BN	Edelstahl matt
FH 061S.AL	EV1 alu eloxiert

BN AL

- Zargenunabhängiges Band
- für 8 – 10 mm Glas



Max. Türgewicht: 40 kg/ 2 Bänder
Max. Türbreite: 1000 mm/ 2 Bänder

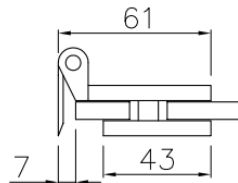
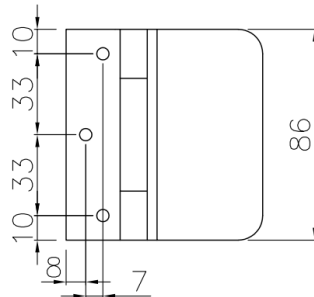

Glas Cut-Out

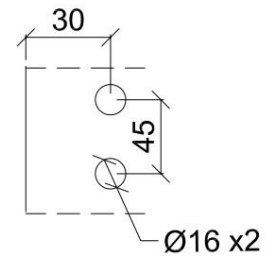

FH 086-GW

Artikelnummer	Oberfläche
FH 086-GW.BN	Edelstahl matt
FH 086-GW.AL	EV1 alu eloxiert
FH 086-GW.PC	Chrom glänzend

BN AL PC

- Zargenunabhängiges Band
- für 8 – 10 mm Glas



Max. Türgewicht: 40 kg/ 2 Bänder
Max. Türbreite: 1000 mm/ 2 Bänder

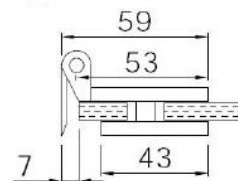
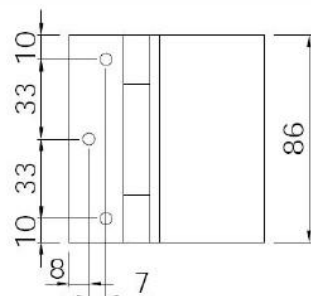

Glas Cut-Out

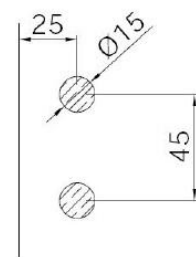

4001

Artikelnummer	Oberfläche
4001.BN	Edelstahl matt
4001.BL	Schwarz matt

BN **BL**

- Aufschraub-Rahmenteil für FH 410-Serie

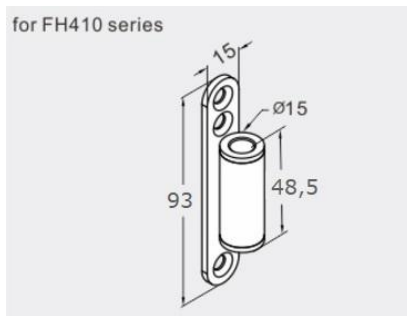

4002

Artikelnummer	Oberfläche
4002.BN	Edelstahl matt

BN

- Aufschraub-Rahmenteil für FH 400-Serie

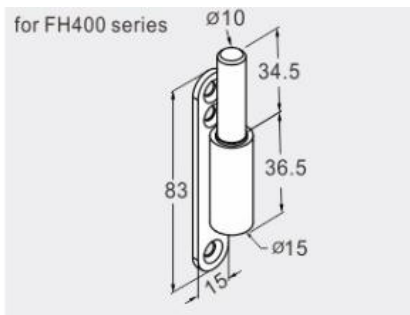

4003

Artikelnummer	Oberfläche
4003.BN	Edelstahl matt

BN

- Rahmenteil für FH 400-Serie
- für Holzarge



4004

Artikelnummer	Oberfläche
4004.BN	Edelstahl matt

BN

- Rahmenteil für FH 400-Serie
- für Stahlzarge

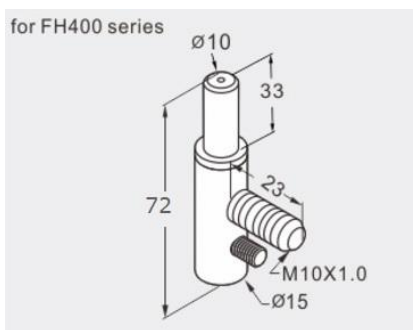

4005

BN

Artikelnummer	Oberfläche
4005.BN	Edelstahl matt

- Rahmenteil für FH 400-Serie

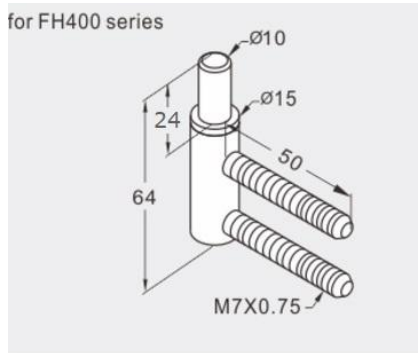

2

5001

BN

Artikelnummer	Oberfläche
5001-L.BN	Edelstahl matt
5001-R.BN	Edelstahl matt

- Rahmenteil für FH 410-Serie
- für Stahlzarge

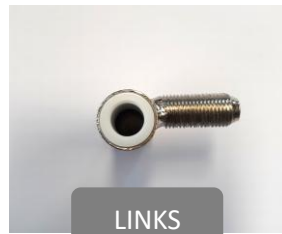
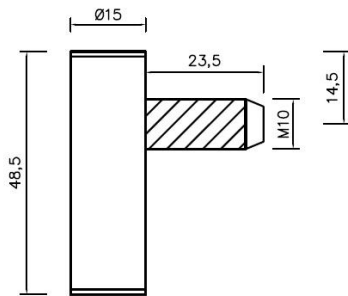

5002

BN

Artikelnummer	Oberfläche
5002.BN	Edelstahl matt

- Rahmenteil für FH 410-Serie
- für Holzzarge

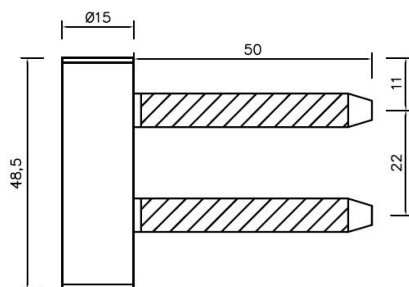

SC-1

Artikelnummer	Oberfläche
SC-1.BN	Edelstahl matt



BN

- Pendeltürband selbstschließend
- Glas/Wand, 90°, beidseitig



Max. Türgewicht: 45 kg
Max. Türbreite: 900 mm

Glas Cut-Out

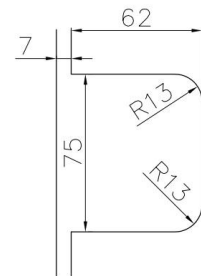

SC-1_asym

Artikelnummer	Oberfläche
SC-1_asym.BN	Edelstahl matt



BN

- Pendeltürband, selbstschließend
- Glas/Wand, 90°, einseitig



Max. Türgewicht: 45 kg
Max. Türbreite: 900 mm

Glas Cut-Out

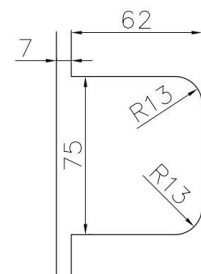

PH 101

BN

Artikelnummer	Oberfläche	Bohrabstand
PH 101.BN	Edelstahl matt	250 mm

- Ø 25 mm
- Glasbohrung Ø 16 mm
- für 8 – 12 mm Glas

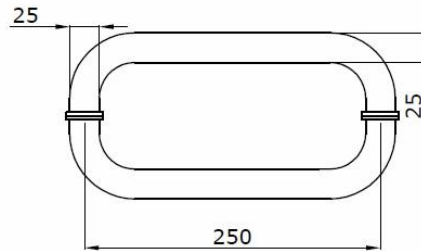

2

PH 102

BN

BL

PC

Artikelnummer	Oberfläche	[A] Länge / [B] Bohrabstand
PH 102-350.BN	Edelstahl matt	350 mm / 250 mm
PH 102-400.BN	Edelstahl matt	400 mm / 250 mm
PH 102-400.PC	Chrom glänzend	400 mm / 250 mm
PH 102-720.BN	Edelstahl matt	720 mm / 620 mm
PH 102-720.BL	Schwarz matt	720 mm / 620 mm
PH 102-800.BN	Edelstahl matt	800 mm / 400 mm
PH 102-1760.BN	Edelstahl matt	1760 mm / 520 mm (4 Glaskonsolen)

- [C] Ø 25 mm
- Glasbohrung Ø 16 mm
- für 8 – 20 mm Glas

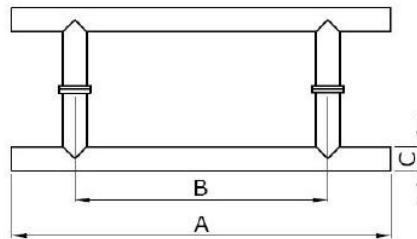

PH 102

BN

Artikelnummer	Oberfläche	[A] Länge / [B] Bohrabstand
PH 102-1000.BN	Edelstahl matt	1000 mm / 600 mm

- [C] Ø 32 mm
- Glasbohrung Ø 16 mm
- für 8 – 20 mm Glas

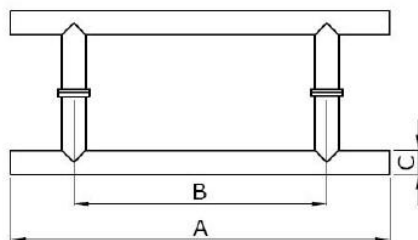

PH 103

BN

Artikelnummer	Oberfläche	Länge / Bohrabstand
PH 103.BN	Edelstahl matt	320 mm / 295 mm

- Ø 25 mm
- Glasbohrung Ø 16 mm
- für 8 – 12 mm Glas

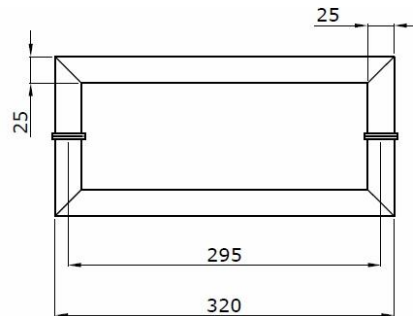

PH 104

BN

BL

WH

Artikelnummer	Oberfläche	[A] Länge / [B] Bohrabstand
PH 104-300.BN	Edelstahl matt	300 mm / 200 mm
PH 104-400.BL	Schwarz matt	400 mm / 300 mm
PH 104-400.WH	Weiß matt RAL 9016	400 mm / 300 mm
PH 104-450.BN	Edelstahl matt	450 mm / 350 mm
PH 104-600.BN	Edelstahl matt	600 mm / 500 mm

- Ø 19 mm
- Glasbohrung Ø 12 mm
- für 8 – 12 mm Glas

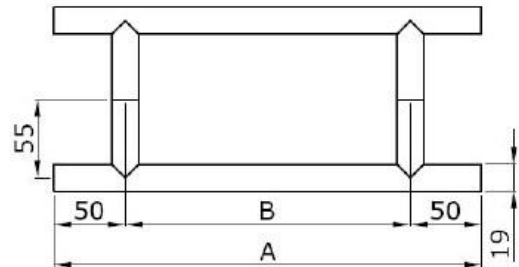

SP 701

PC BN

Artikelnummer	Oberfläche	Länge / Bohrabstand
SP 701.PC	Chrom glänzend	222 mm / 203 mm
SP 701.BN	Edelstahl matt	222 mm / 203 mm

- Ø 19 mm
- Glasbohrung Ø 14 mm
- für 8 – 12 mm Glas

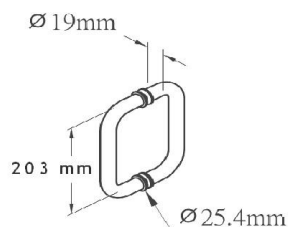

TB 702

PC BN

Artikelnummer	Oberfläche	Länge / Bohrabstand
TB 702.PC	Chrom glänzend	628 mm / 609 mm
TB 702.BN	Edelstahl matt	628 mm / 609 mm

- Ø 19 mm
- Glasbohrung Ø 14 mm
- für 8 – 12 mm Glas

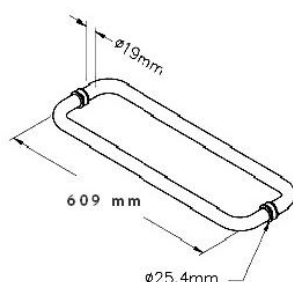

SP 800

PC BN BL

Artikelnummer	Oberfläche	Länge / Bohrabstand
SP 800-610.BN	Edelstahl matt	629 mm / 610 mm
SP 800-305.PC	Chrom glänzend	324 mm / 305 mm
SP 800-305.BN	Edelstahl matt	324 mm / 305 mm
SP 800-305.BL	Schwarz matt	324 mm / 305 mm

- 19 x 19 mm
- Glasbohrung Ø 10 mm
- für 8 – 12 mm Glas



PHL 1200B

BN

Artikelnummer	Oberfläche	Länge
PHL 1200B.BN	Edelstahl matt	1200 mm

- beidseitig sperrbar
- Ausladung 88 mm
- inkl. 1 Bodenbuchse
- vorbereitet für Profilzylinder 160/30 mm

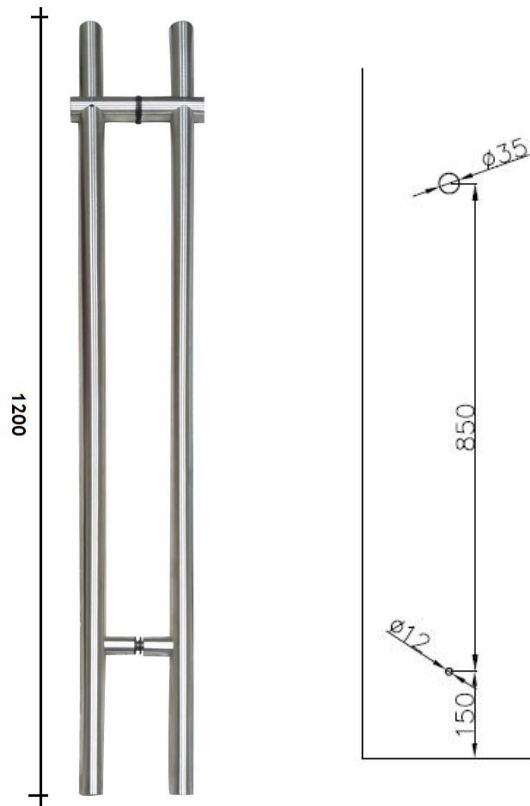

PHL 1200S

BN

Artikelnummer	Oberfläche	Länge
PHL 1200S.BN	Edelstahl matt	1200 mm

- einseitig sperrbar
- Ausladung 78 mm
- inkl. 1 Bodenbuchse
- vorbereitet für Profil-Halb-Zylinder 10/30 mm

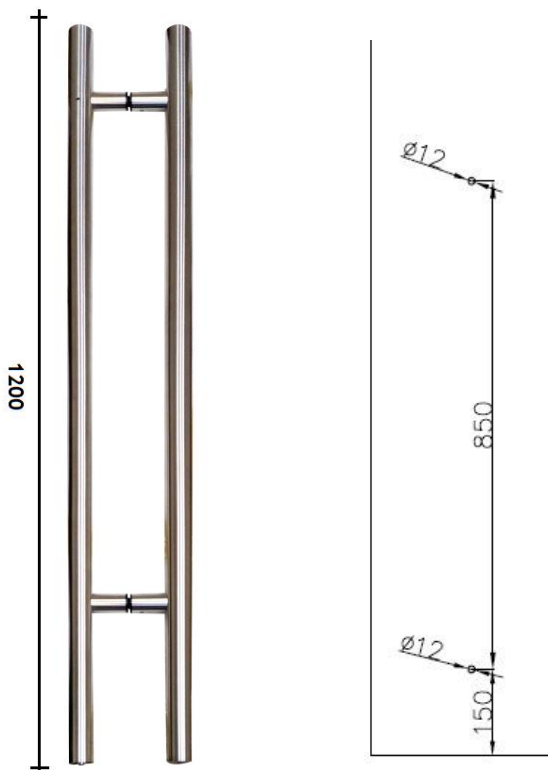

PHL 1300B

Artikelnummer	Oberfläche	Länge
PHL 1300B.BN	Edelstahl matt	1200 mm

BN

- beidseitig sperrbar
- Ausladung 88 mm
- inkl. 1 Bodenbuchse
- vorgerichtet für Profizylinder 80/30 mm

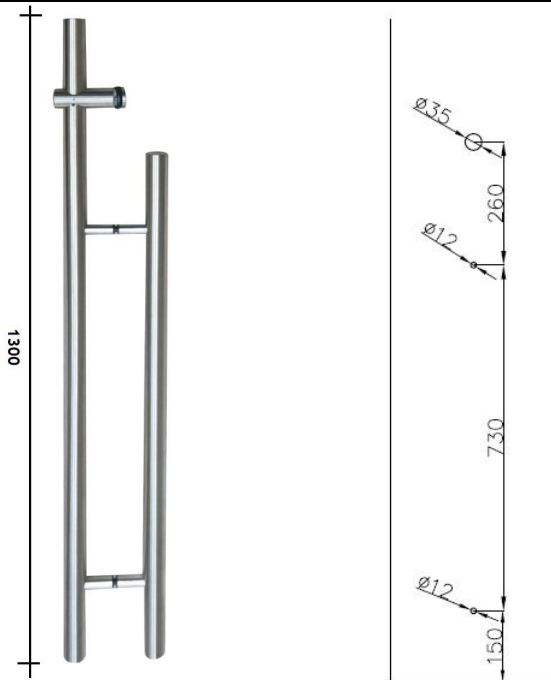

2

PC 160/30

Artikelnummer	Oberfläche
PC 160/30.BN	Edelstahl matt

BN

- Profizylinder 160/30 mm
- verschiedenschließend

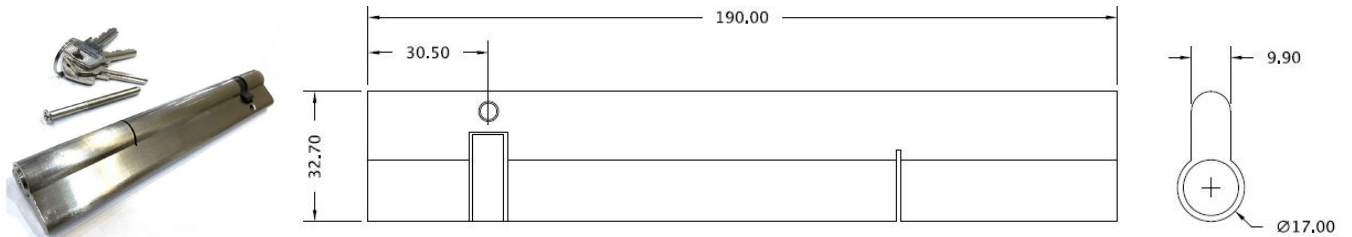

PC 10/30

Artikelnummer	Oberfläche
PC 10/30.BN	Edelstahl matt

BN

- Profil-Halb-Zylinder 10/30 mm
- verschiedenschließend

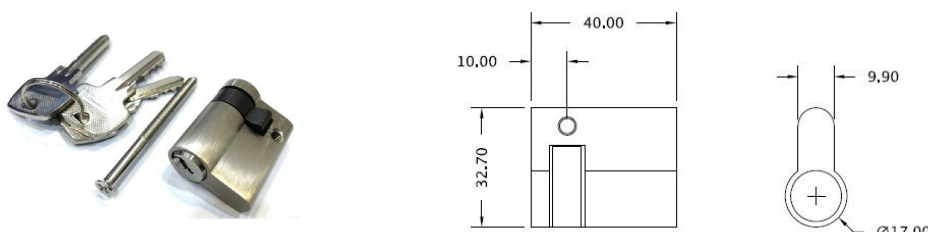

PC 80/30

Artikelnummer	Oberfläche
PC 80/30.BN	Edelstahl matt

BN

- Profizylinder 80/30 mm
- verschiedenschließend

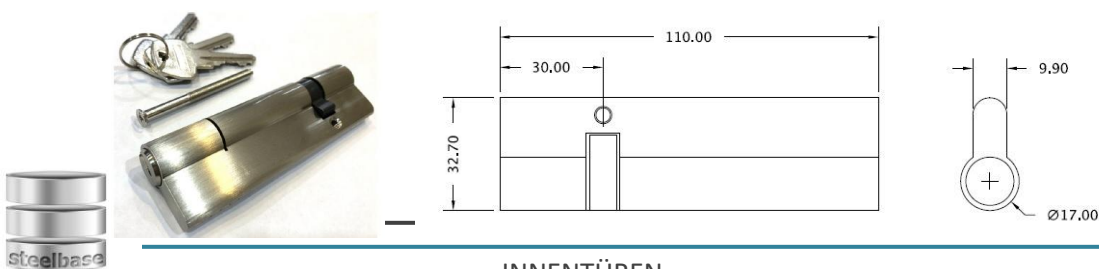

steelbase

H 362X

BN

Artikelnummer	Oberfläche
H 362X.BN	Edelstahl matt

- Türstopper



CY 805

BN

Artikelnummer	Oberfläche
CY 805.BN	Edelstahl matt

- Türstopper

