

VORDÄCHER



CP 60 Vordachsystem

144

CP 80 Vordachsystem

147



6



CP 60-Set

V2A V4A

Artikelnummer	Material/Oberfläche
CP 60-Set.V2A Standardlänge	V2A Edelstahl matt
CP 60-Set.V4A Standardlänge	V4A Edelstahl matt

- Set bestehend aus:

1 Stk. CP 60-A + 1 Stk. CP 60-B + 1 Stk. CP 60-C
+ 1 Stk. CP 60/80-D Standardlänge



Standardlänge CP 60/80-D =
L = 900 mm (nur in V2A erhältlich)
L = 1057 mm
L = 1130 mm
L = 1208 mm
L = 1285 mm
L = 1362 mm
L = 1442 mm

Schematische Ansicht auf Seite 145 + 146

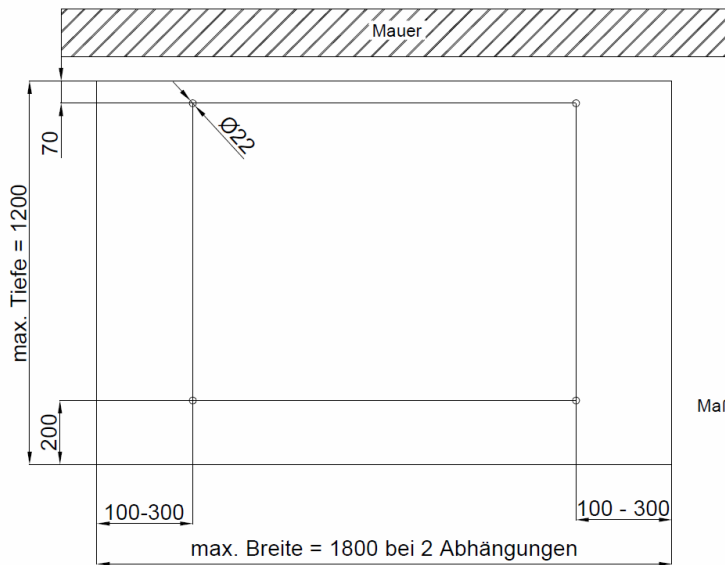

Maße in mm



CP 60-A

V2A V4A

Artikelnummer	Material/Oberfläche
CP 60-A.V2A	V2A Edelstahl matt
CP 60-A.V4A	V4A Edelstahl matt

- Glashalter - Wandanschluss

- Glasbohrung Ø 22 mm

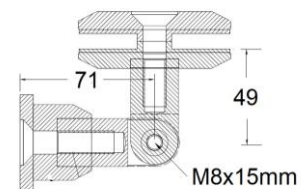
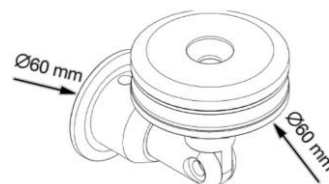

CP 60-B

Artikelnummer	Material/Oberfläche
CP 60-B.V2A	V2A Edelstahl matt
CP 60-B.V4A	V4A Edelstahl matt

V2A V4A

- Wandanschluss
- für Zugstange Gewinde M12

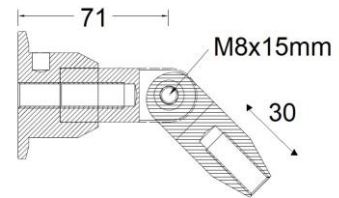
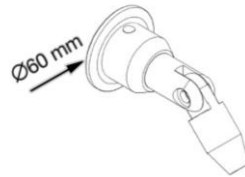

CP 60-C

Artikelnummer	Material/Oberfläche
CP 60-C.V2A	V2A Edelstahl matt
CP 60-C.V4A	V4A Edelstahl matt

V2A V4A

- Glashalter - Zugstange
- Glasbohrung \varnothing 22 mm
- für Zugstange Gewinde M12

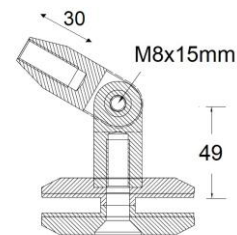
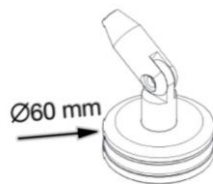

CP 60/80-D

Artikelnummer	Material/Oberfläche
CP 60/80-D.V2A Standardlänge	V2A Edelstahl matt
CP 60/80-D.V4A Standardlänge	V4A Edelstahl matt

V2A V4A

- Zugstange, Gewinde M12

Standardlänge CP 60/80-D =

- L = 900 mm (nur in V2A erhältlich)
- L = 1057 mm
- L = 1130 mm
- L = 1208 mm
- L = 1285 mm
- L = 1362 mm
- L = 1442 mm



CP 60-G

Artikelnummer	Material/Oberfläche
CP 60-G.V2A	V2A Edelstahl matt
CP 60-G.V4A	V4A Edelstahl matt

V2A V4A

- Wandanschluss mit Platte 160 x 50 mm
- für Zugstange Gewinde M12

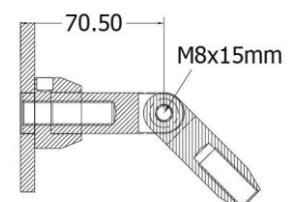
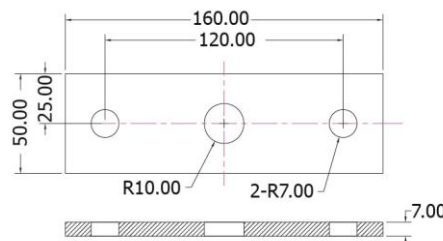

6



CP 60-H

V2A

Artikelnummer	Material/Oberfläche
CP 60-H.V2A	V2A Edelstahl matt

- Wandanschluss mit Platte 220 x 50 mm
- für Zugstange Gewinde M12

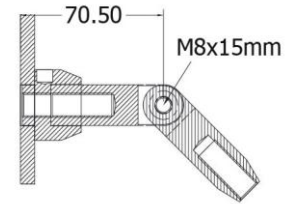
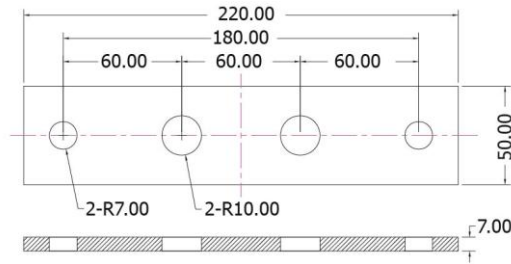

CP 60-I

V2A

V4A

Artikelnummer	Material/Oberfläche
CP 60-I.V2A	V2A Edelstahl matt
CP 60-I.V4A	V4A Edelstahl matt

- Wandanschluss mit Platte \varnothing 160 mm
- für Zugstange Gewinde M12

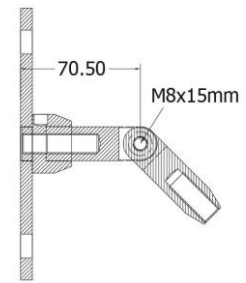
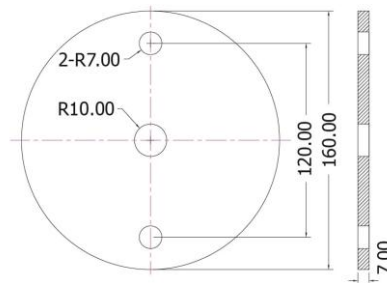

CP 60-J

V2A

Artikelnummer	Material/Oberfläche
CP 60-J.V2A	V2A Edelstahl matt

- Wandanschluss mit Platte \varnothing 160 mm
- für Zugstange Gewinde M12

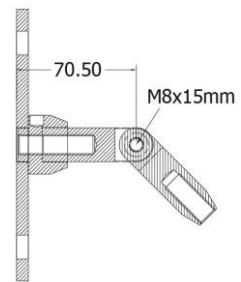
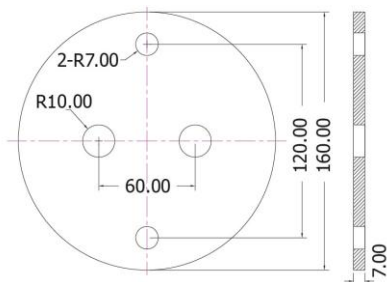

CP 60-L

V2A

V4A

Artikelnummer	Material/Oberfläche
CP 60-L.V2A	V2A Edelstahl matt
CP 60-L.V4A	V4A Edelstahl matt

- Wandanschluss mit Platte 160 x 50 mm
- Glasbohrung \varnothing 22 mm

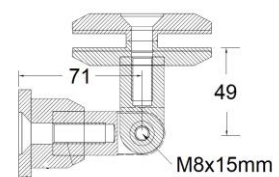
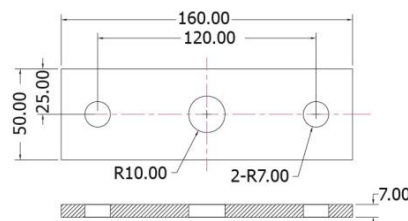

CP 80-Set

V2A V4A

Artikelnummer	Material/Oberfläche
CP 80-Set.V2A Standardlänge	V2A Edelstahl matt
CP 80-Set.V4A Standardlänge	V4A Edelstahl matt

- Set bestehend aus:

1 Stk. CP 80-A + 1 Stk. CP 80-B + 1 Stk. CP 80-C
+ 1 Stk. CP 60/80-D Standardlänge



Standardlänge CP 60/80-D =
L = 900 mm (nur in V2A erhältlich)
L = 1057 mm
L = 1130 mm
L = 1208 mm
L = 1285 mm
L = 1362 mm
L = 1442 mm

Schematische Ansicht auf Seite 145 + 146

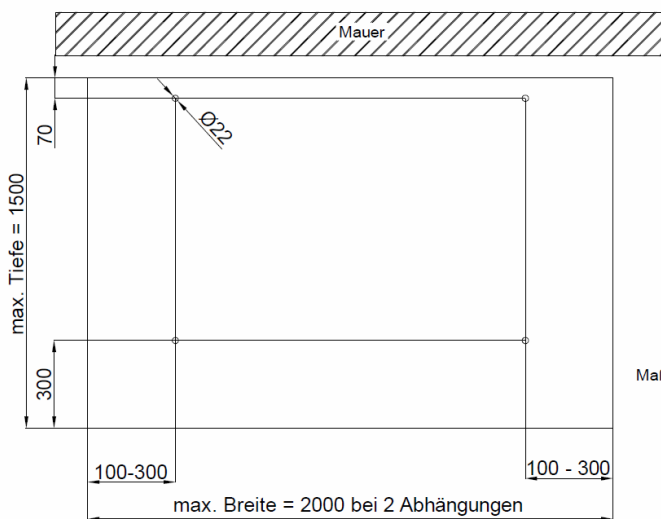

Maße in mm



6

CP 80-A

V2A V4A

Artikelnummer	Material/Oberfläche
CP 80-A.V2A	V2A Edelstahl matt
CP 80-A.V4A	V4A Edelstahl matt

- Glashalter - Wandanschluss

- Glasbohrung Ø 22 mm

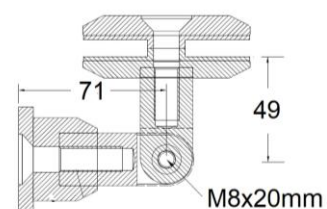
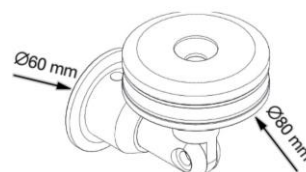

CP 80-B

Artikelnummer	Material/Oberfläche
CP 80-B.V2A	V2A Edelstahl matt
CP 80-B.V4A	V4A Edelstahl matt

V2A V4A

- Wandanschluss
- für Zugstange Gewinde M12

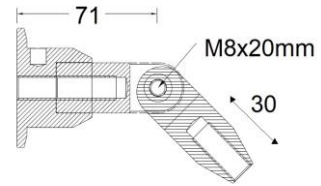
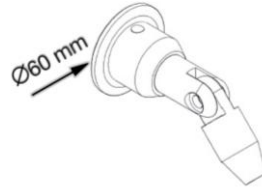

CP 80-C

Artikelnummer	Material/Oberfläche
CP 80-C.V2A	V2A Edelstahl matt
CP 80-C.V4A	V4A Edelstahl matt

V2A V4A

- Glashalter - Zugstange
- Glasbohrung Ø 22 mm
- für Zugstange Gewinde M12

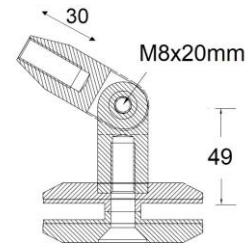
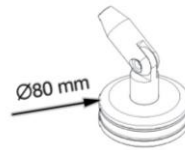

CP 60/80-D

Artikelnummer	Material/Oberfläche
CP 60/80-D.V2A Standardlänge	V2A Edelstahl matt
CP 60/80-D.V4A Standardlänge	V4A Edelstahl matt

V2A V4A

- Zugstange, Gewinde M12

Standardlänge CP 60/80-D =

L = 900 mm (nur in V2A erhältlich)

L = 1057 mm

L = 1130 mm

L = 1208 mm

L = 1285 mm

L = 1362 mm

L = 1442 mm



CP 80-E

Artikelnummer	Material/Oberfläche
CP 80-E.V2A	V2A Edelstahl matt
CP 80-E.V4A	V4A Edelstahl matt

V2A V4A

- Zugstangenhalter mit 2 Glashaltern
- für Zugstange Gewinde M12
- Glasbohrung Ø 22 mm

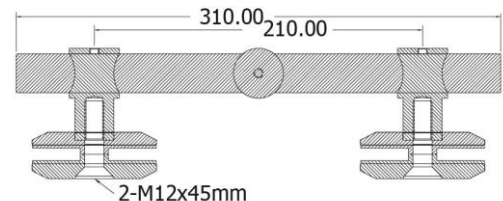
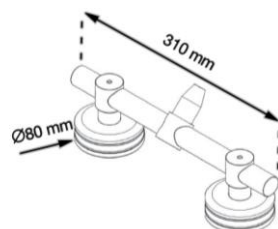

CP 80-F

Artikelnummer	Material/Oberfläche
CP 80-F.V2A	V2A Edelstahl matt
CP 80-F.V4A	V4A Edelstahl matt

V2A V4A

- Glashalter mit 2 Zugstangenhaltern
- für Zugstange Gewinde M12
- Glasbohrung \varnothing 22 mm



CP 80-G

Artikelnummer	Material/Oberfläche
CP 80-G.V2A	V2A Edelstahl matt
CP 80-G.V4A	V4A Edelstahl matt

V2A V4A

- Wandanschluss mit Platte 160 x 50 mm
- für Zugstange Gewinde M12

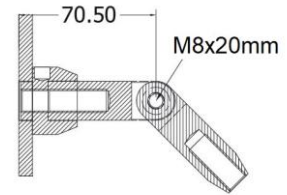
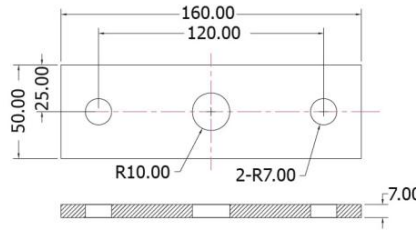

CP 80-H

Artikelnummer	Material/Oberfläche
CP 80-H.V2A	V2A Edelstahl matt

V2A

- Wandanschluss mit Platte 220 x 50 mm
- für Zugstange Gewinde M12

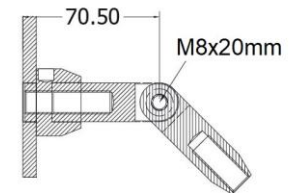
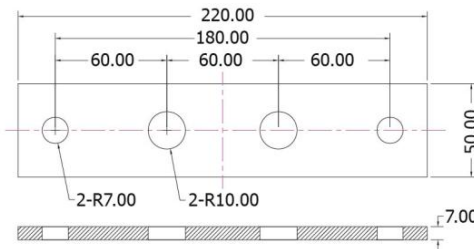

CP 80-I

Artikelnummer	Material/Oberfläche
CP 80-I.V2A	V2A Edelstahl matt
CP 80-I.V4A	V4A Edelstahl matt

V2A V4A

- Wandanschluss mit Platte \varnothing 160 mm
- für Zugstange Gewinde M12

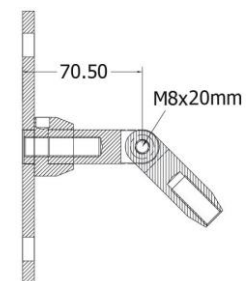
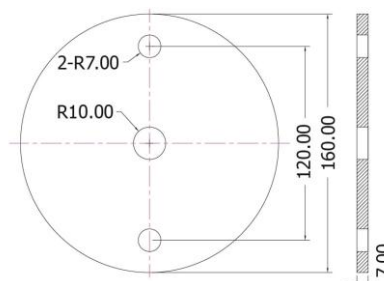

6



CP 80-J

V2A

Artikelnummer	Material/Oberfläche
CP 80-J.V2A	V2A Edelstahl matt

- Wandanschluss mit Platte \varnothing 160 mm
- für Zugstange Gewinde M12

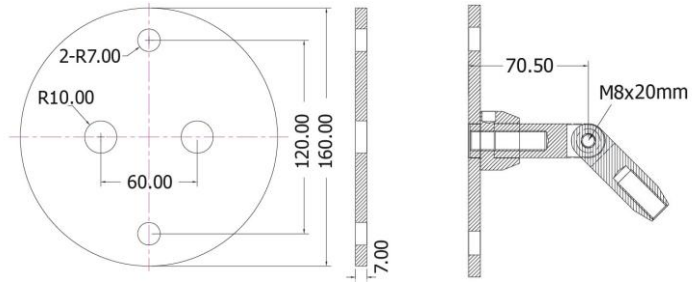

CP 80-K

V2A

Artikelnummer	Material/Oberfläche
CP 80-K.V2A	V2A Edelstahl matt

- Wandanschluss mit 2 Glashaltern
- Glasbohrung \varnothing 22 mm

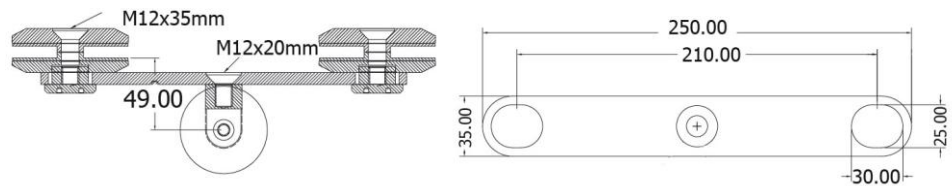
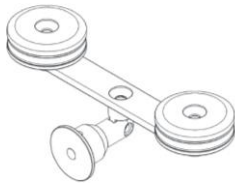

CP 80-L

V2A

V4A

Artikelnummer	Material/Oberfläche
CP 80-L.V2A	V2A Edelstahl matt
CP 80-L.V4A	V4A Edelstahl matt

- Wandanschluss mit Platte 160 x 50 mm
- Glasbohrung \varnothing 22 mm

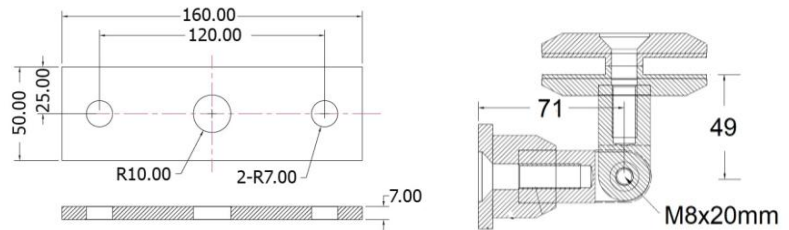

Schematische Ansicht

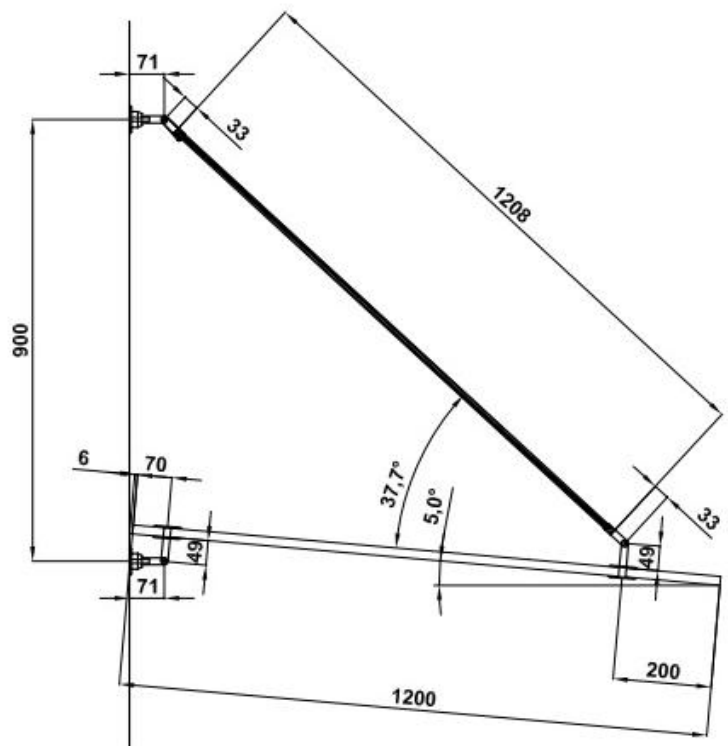
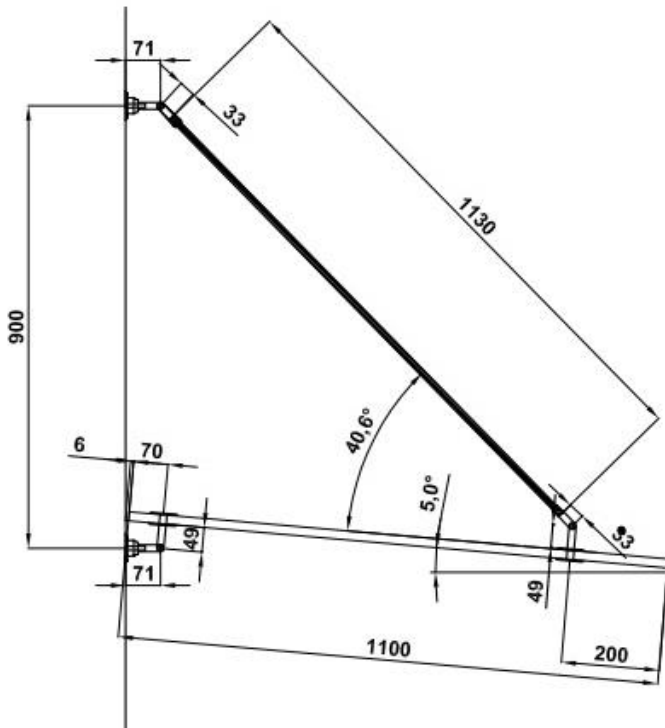
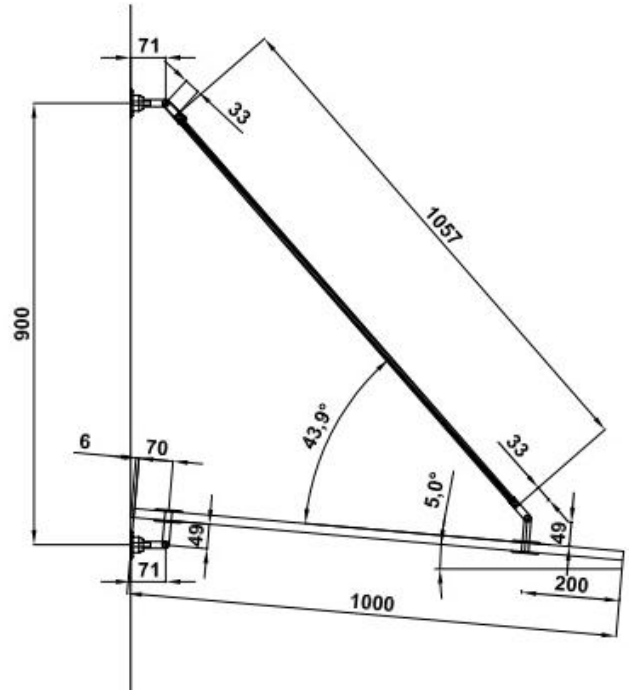
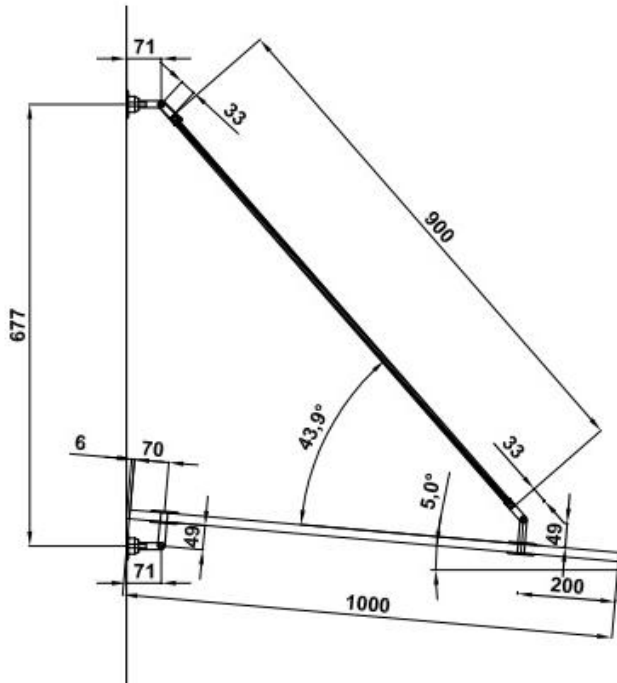

6



